

PRELIMINARY DRAWING - FOR LAYOUT PURPOSES ONLY

REVISIONS			
REV	DESCRIPTION	DATE	BY

NOTE 1: Do not scale drawing. This drawing is for general truck configuration only. All items and dimensions shown are approximate and may vary with final production. The drawing may not provide illustration for all items in the specification. In all situations where the drawing may contradict the specifications, the specifications shall prevail. This drawing and all data herein are provided as confidential materials and shall not be reproduced without written consent of the manufacturer.

NOTE 2: Chassis frame height will change due to axle characteristics, loading and the dimensions which will effect the overall height dimension shown. Any overall height restrictions should take this into consideration and allow approximately 2-3 inches of tolerance.

SAVE FOR EPS
MICROWAVE ANTENNAS

VERTICAL EXHAUST FOR
DIESEL GENERATOR

SHOREPOWER
NOT AUTO-EJECT

151 1/2"
[12'-7 1/2"]
OAH
SEE NOTE 2

360"
[30']

302" WHEELBASE

235" CAB TO AXLE

484"
[40'-4"]



LOVELAND SVI COLORADO

SVI FIRE & RESCUE TRUCKS
1511 E. 11th STREET, LOVELAND, CO 80537 PHONE 970-667-5146, FAX 970-667-3343

**EDMONTON
POLICE SERVICES**

BODY SIZE: 30' BODY	UNIT TYPE: COMMAND
BODY MATERIAL: 3/16" ALUMINUM	TRUCK NO: SVI #825
CHASSIS TYPE: INTERNATIONAL	WHEELBASE: SEE DWG
---	CAB TO AXLE: SEE DWG
FLAT	OVERALL LENGTH (OAL): SEE DWG
TWO DOOR	OVERALL WIDTH (OAW): SEE DWG
	OVERALL HEIGHT (OAH): SEE DWG

DRAWN BY: *Dennis* DATE: Jul 12, 07 SCALE: 3/32" = 1'-0"
 DRAWING NO: *C:\Users\james\Documents\EdmontonPO_A8.dwg* SHEET 1 OF 3
Graphics\EdmontonPO_A8.dwg

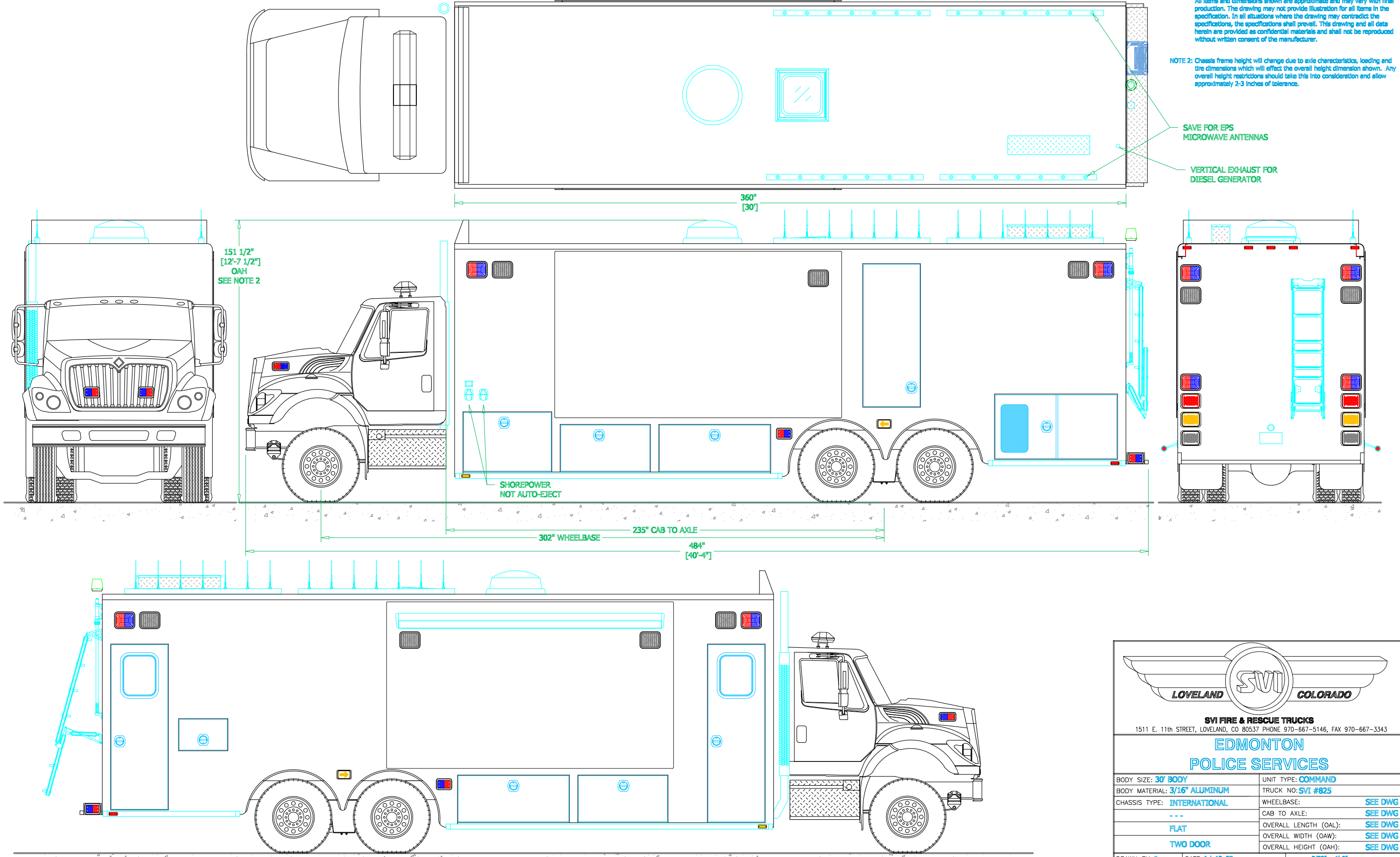

PRELIMINARY DRAWING - FOR LAYOUT PURPOSES ONLY

REVISIONS			
REV	DESCRIPTION	DATE	BY

NOTE 1: Do not scale drawing. This drawing is for general truck configuration only. All items and dimensions shown are approximate and may vary with final production. The drawing may not provide illustration for all items in the specification. In all situations where the drawing may contradict the specifications, the specifications shall prevail. This drawing and all data herein are provided as confidential materials and shall not be reproduced without written consent of the manufacturer.

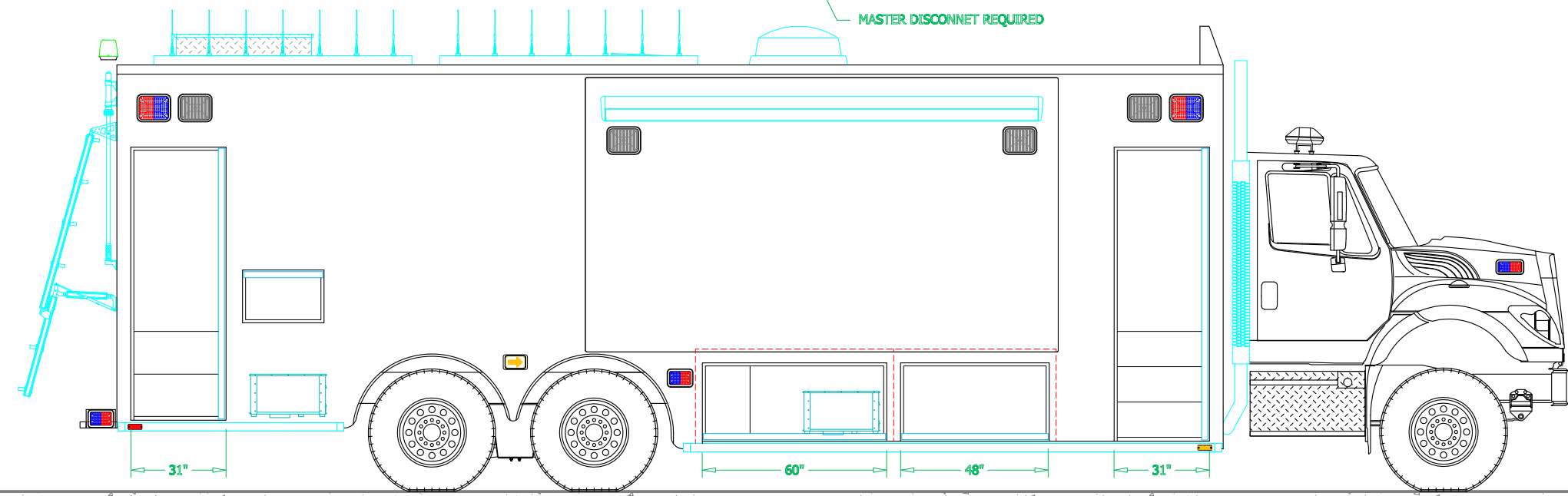
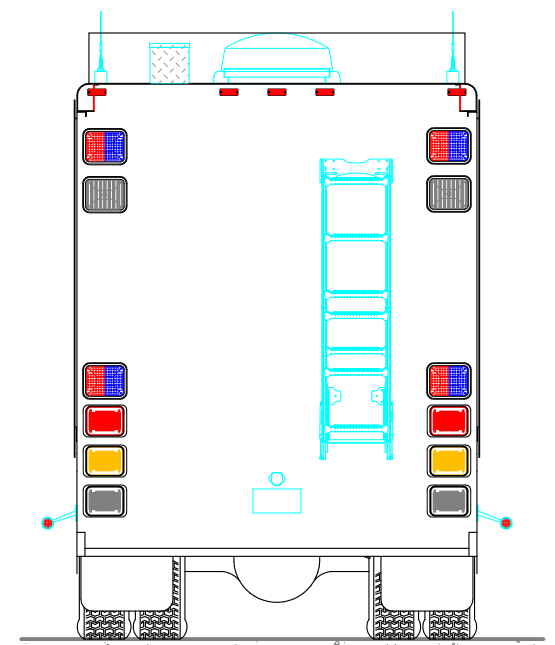
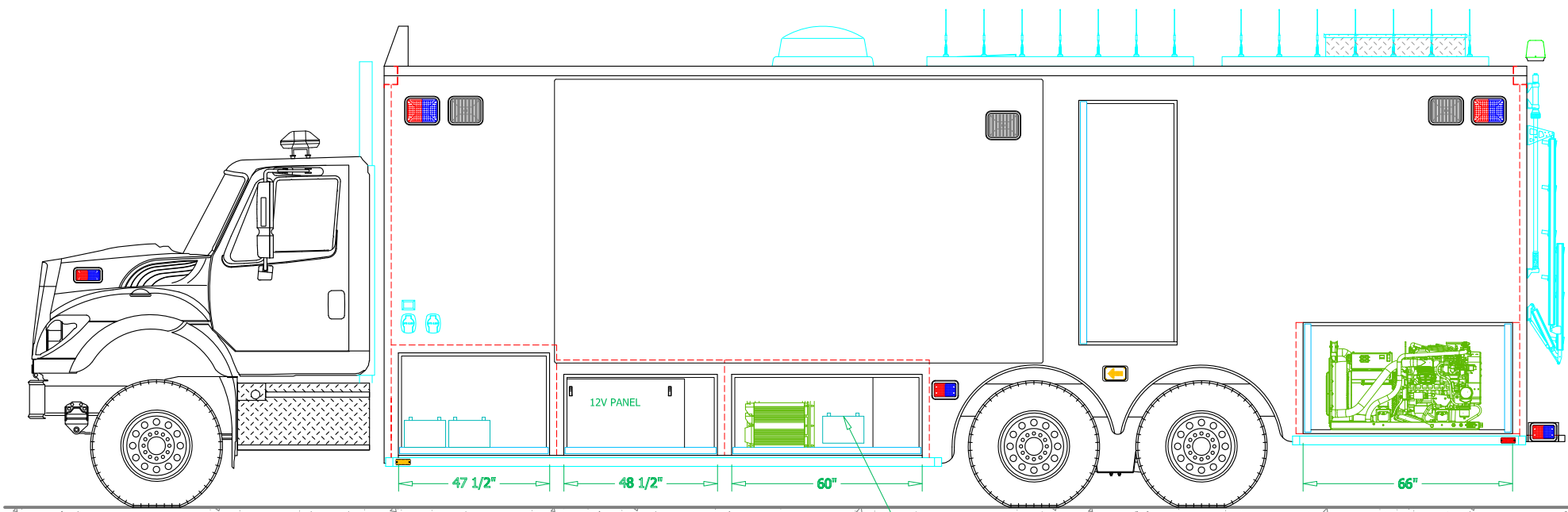
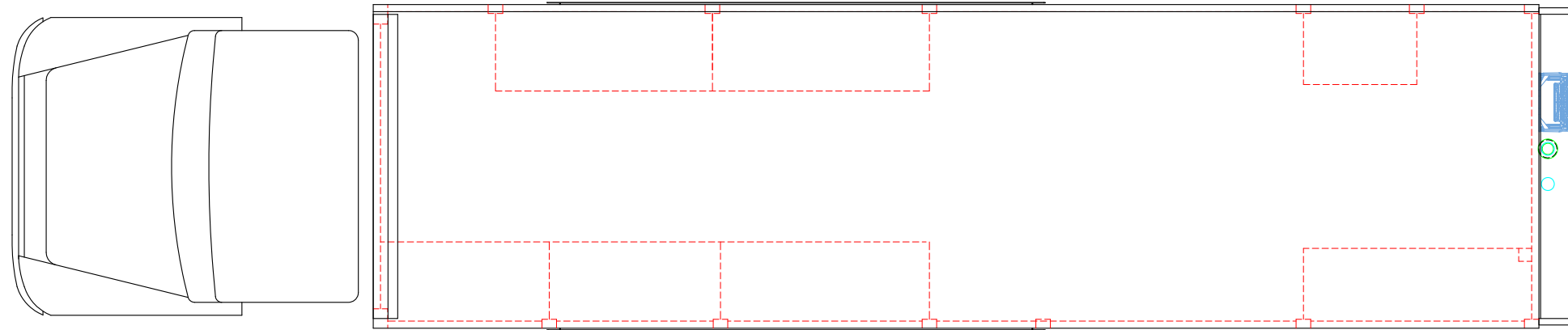



LOVELAND SVI COLORADO

SVI FIRE & RESCUE TRUCKS
1511 E. 11th STREET, LOVELAND, CO 80537 PHONE 970-667-5146, FAX 970-667-3343

EDMONTON POLICE SERVICES

DRAWN BY: Drew DATE: Jul 12, 07 SCALE: 1" = 1'-0"	SHEET 2 OF 3
DRAWING NO: Documents\6 Drawings & Graphics\edmonton\PO_JCS_CR_S0CSZ	

PRELIMINARY DRAWING - FOR LAYOUT PURPOSES ONLY

REVISIONS			
REV	DESCRIPTION	DATE	BY

NOTE 1: Do not scale drawing. This drawing is for general truck configuration only. All items and dimensions shown are approximate and may vary with final production. The drawing may not provide illustration for all items in the specification. In all situations where the drawing may contradict the specifications, the specifications shall prevail. This drawing and all data herein are provided as confidential materials and shall not be reproduced without written consent of the manufacturer.

PLAN VIEW
CROSS-SECTION

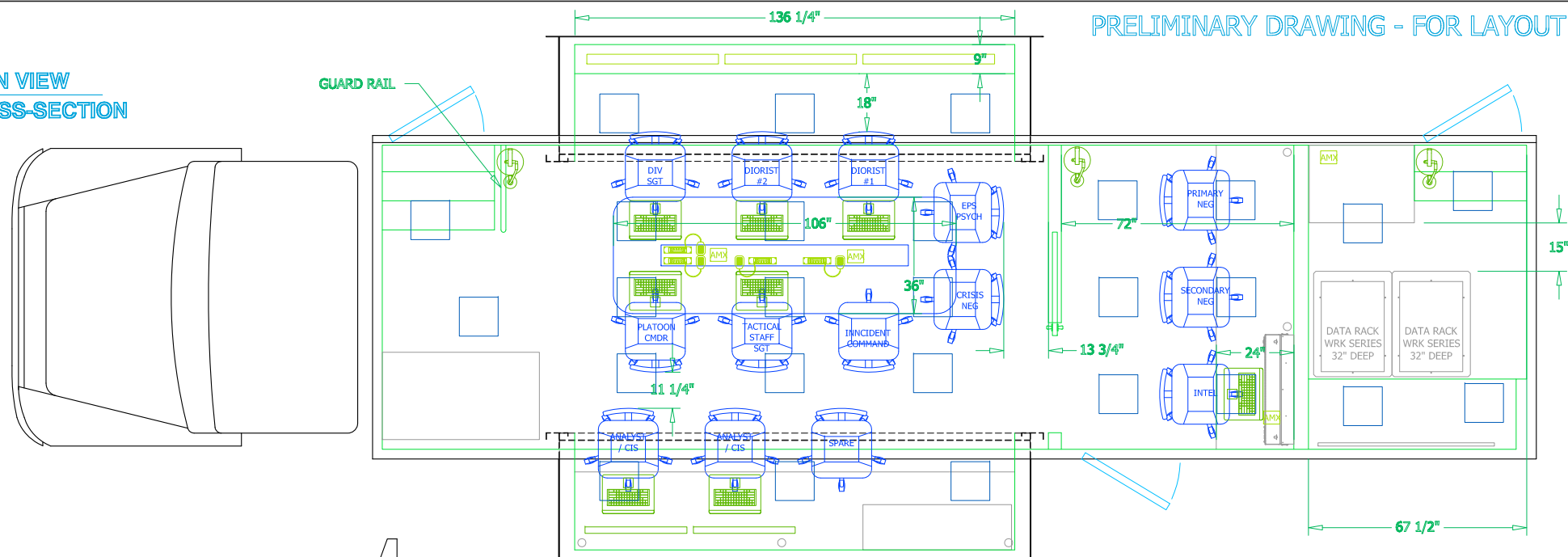

REAR VIEW
CROSS-SECTION

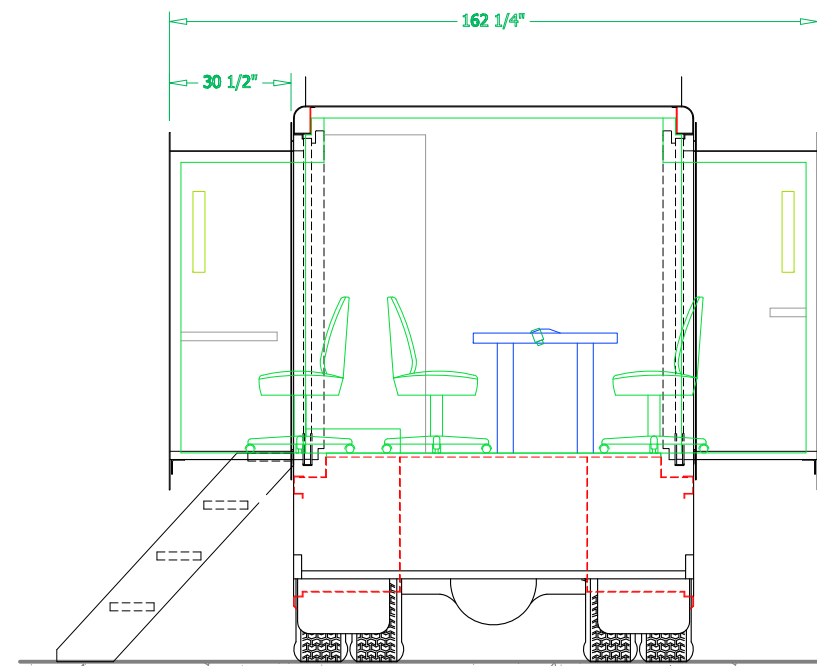

CURBSIDE INTERIOR
CROSS-SECTION

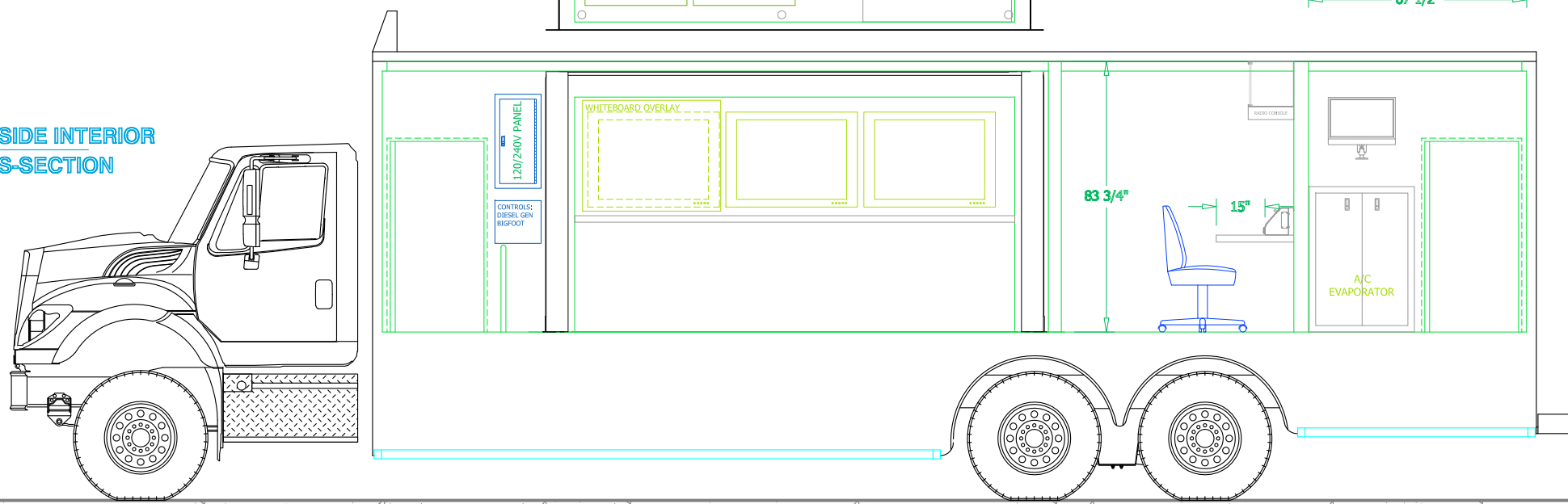

STREETSIDE INTERIOR
CROSS-SECTION

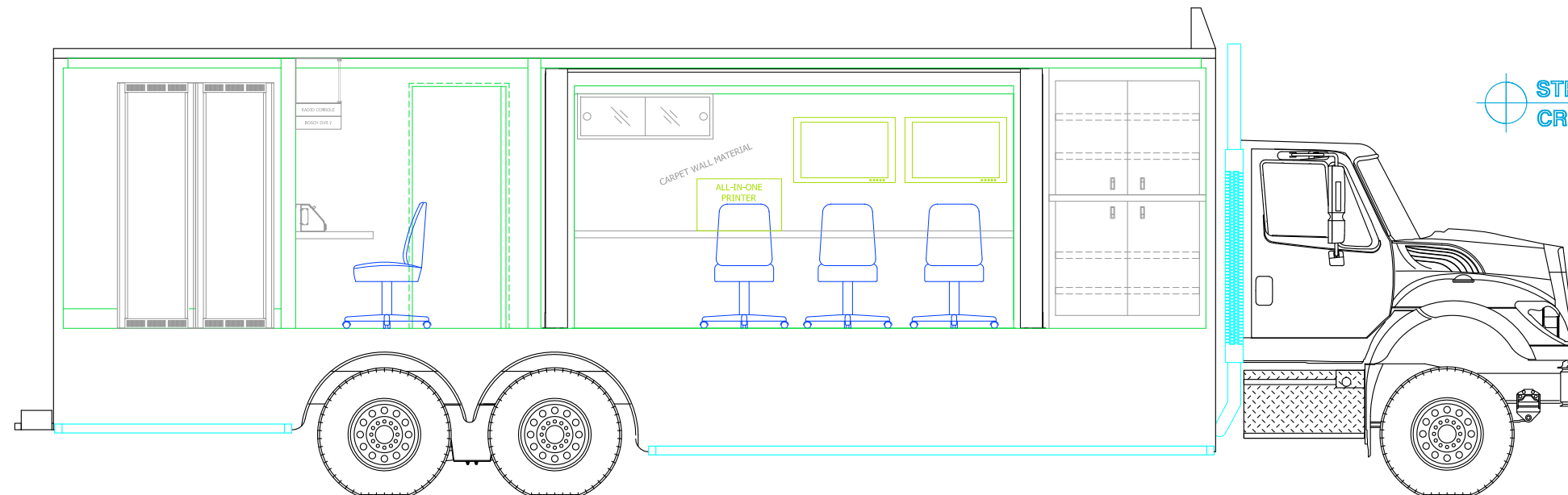



LOVELAND SVI COLORADO

SVI FIRE & RESCUE TRUCKS
1511 E. 11th STREET, LOVELAND, CO 80537 PHONE 970-667-5146, FAX 970-667-3343

EDMONTON POLICE SERVICES

DRAWN BY: Drew DATE: Jul 12, 07 SCALE: 1" = 1'-0"	SHEET 2 OF 3
DRAWING NO: Documents\6 Drawings & Graphics\edmontonPO_A3_Cr_Socsz	

PRELIMINARY DRAWING - FOR LAYOUT PURPOSES ONLY

REVISIONS			
REV	DESCRIPTION	DATE	BY

NOTE 1: Do not scale drawing. This drawing is for general truck configuration only. All items and dimensions shown are approximate and may vary with final production. The drawing may not provide illustration for all items in the specification. In all situations where the drawing may contradict the specifications, the specifications shall prevail. This drawing and all data herein are provided as confidential materials and shall not be reproduced without written consent of the manufacturer.

COMMAND AREA
CROSS-SECTION
LOOKING FORWARD

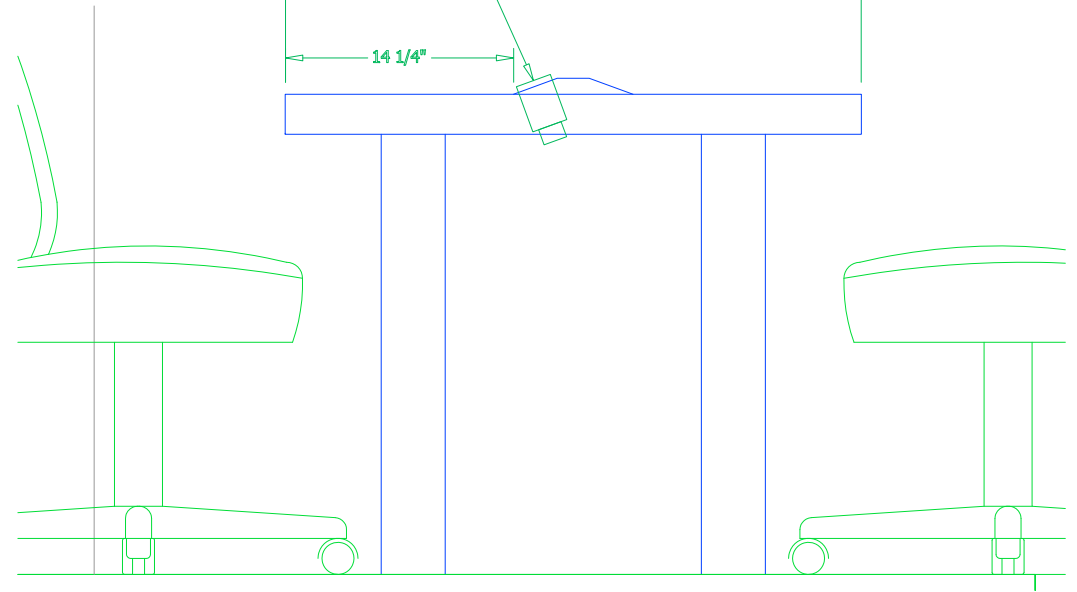
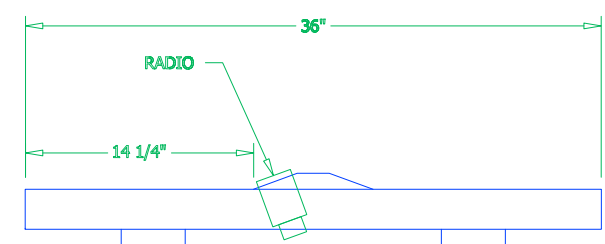
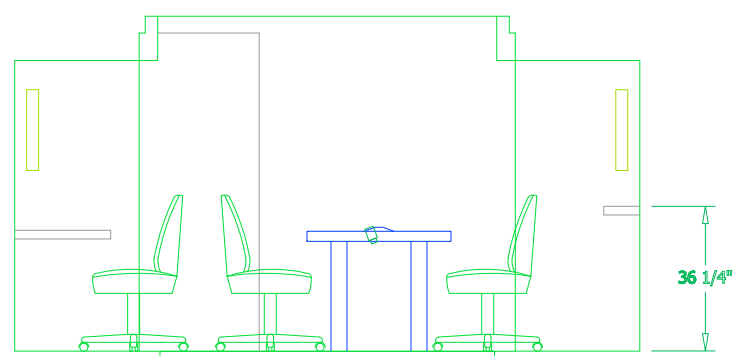

NEGOTIATIONS AREA
CROSS-SECTION
LOOKING REARWARD

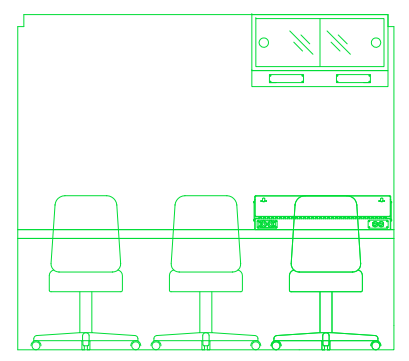

TECH RESOURCE AREA
CROSS-SECTION
LOOKING REARWARD

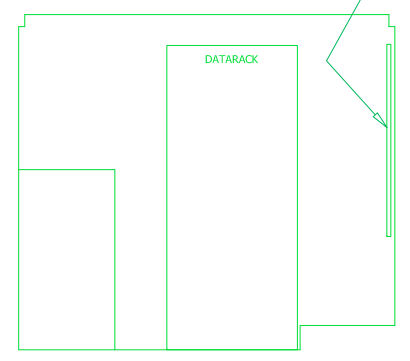

TECH RESOURCE
INTERFACE PANEL

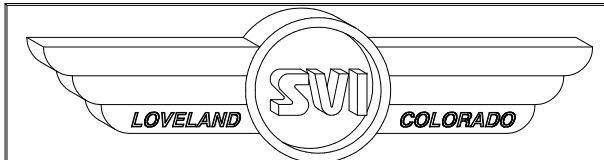
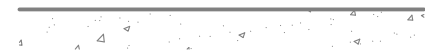
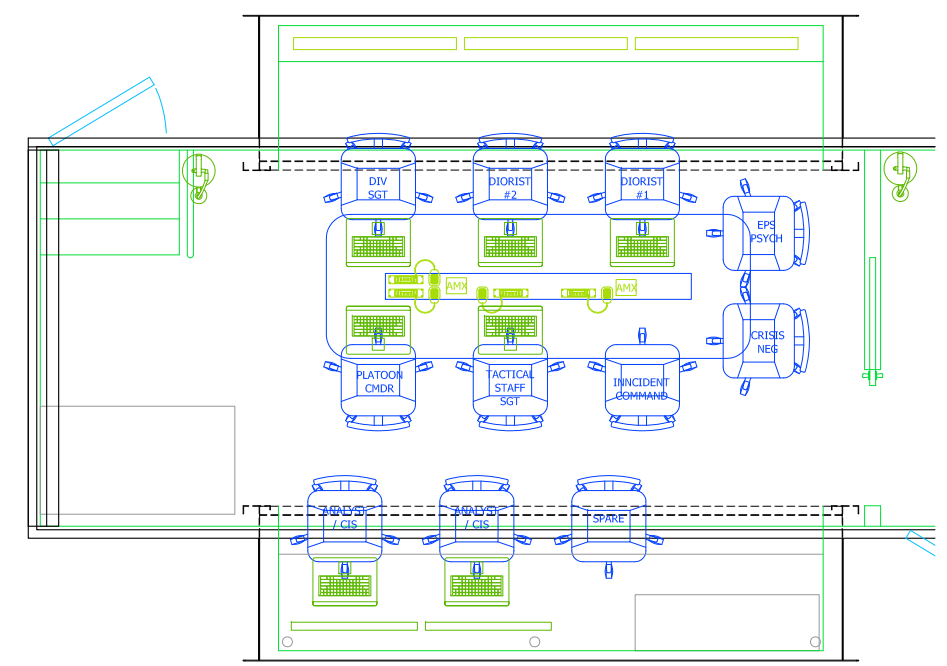

SVI FIRE & RESCUE TRUCKS
1511 E. 11th STREET, LOVELAND, CO 80537 PHONE 970-667-5146, FAX 970-667-3343

EDMONTON
POLICE SERVICES