

PRELIMINARY DRAWING - FOR LAYOUT PURPOSES ONLY

REVISIONS			
REV	DESCRIPTION	DATE	BY

NOTE 1: Do not scale drawing. This drawing is for general truck configuration only. All items and dimensions shown are approximate and may vary with final production. The drawing may not provide illustration for all items in the specification. In all situations where the drawing may contradict the specifications, the specifications shall prevail. This drawing and all data herein are provided as confidential materials and shall not be reproduced without written consent of the manufacturer.

NOTE 2: Chassis frame height will change due to axle characteristics, loading and the dimensions which will effect the overall height dimension shown. Any overall height restrictions should take this into consideration and allow approximately 2-3 inches of tolerance.

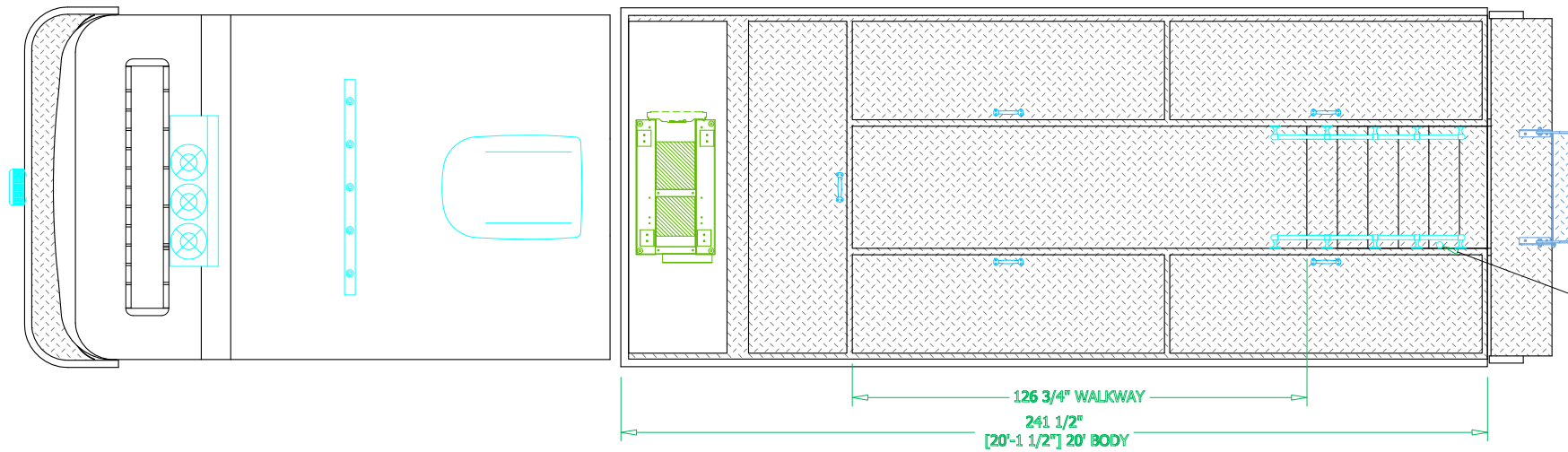

WEATHER STATION MOUNT

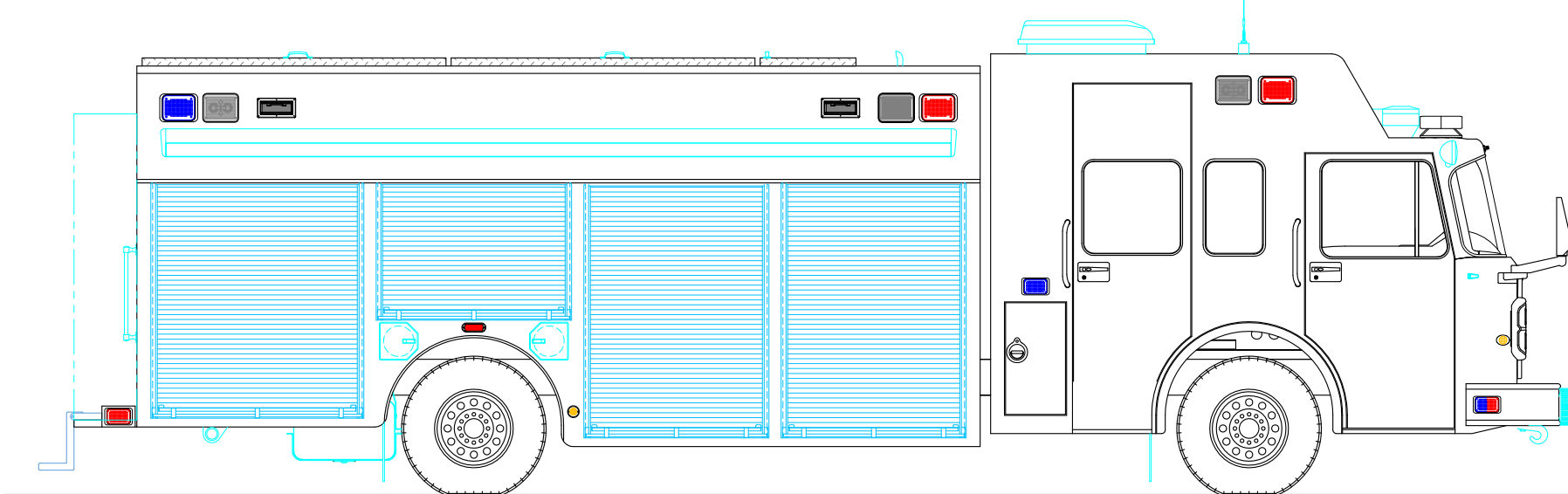
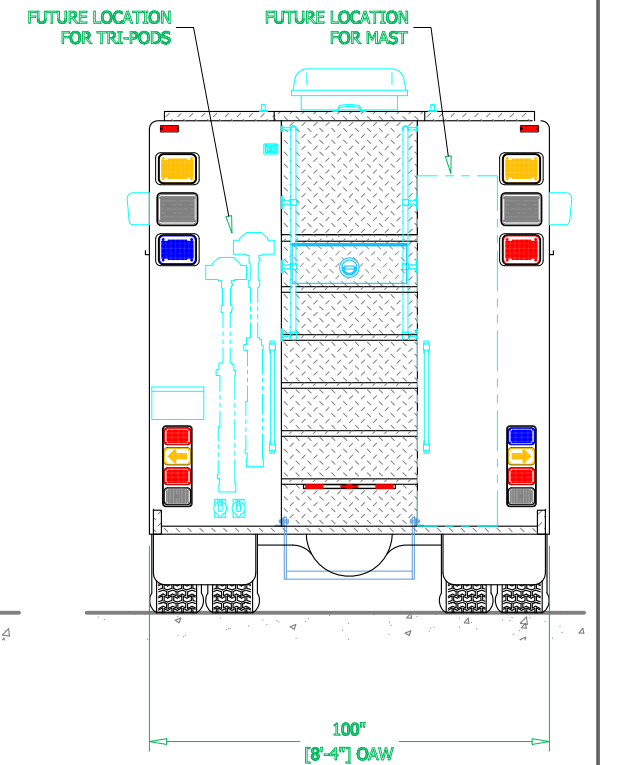
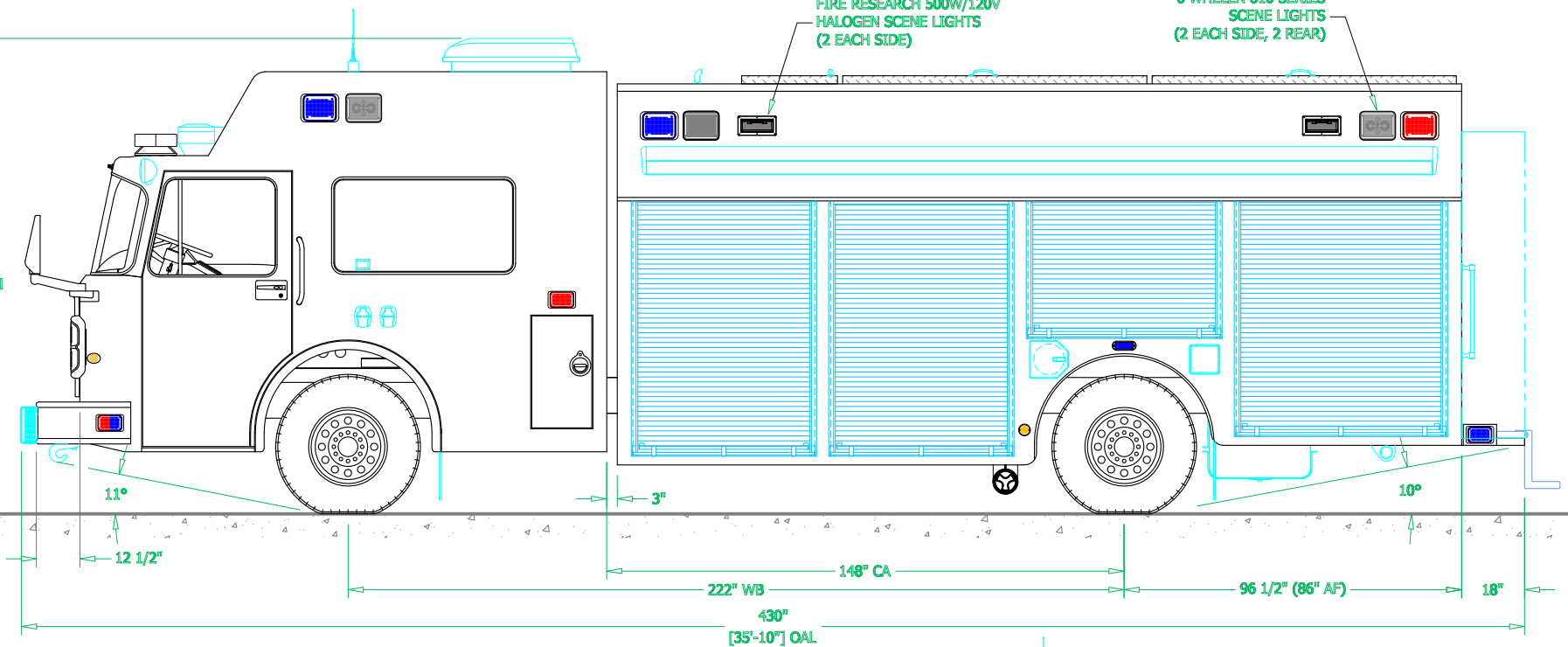
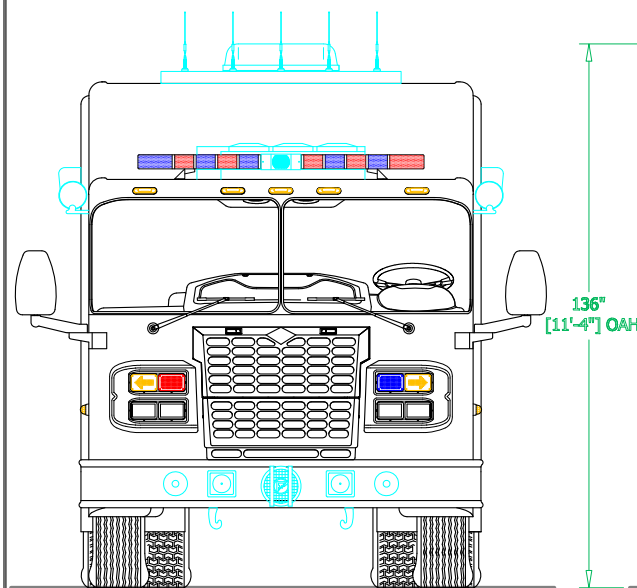

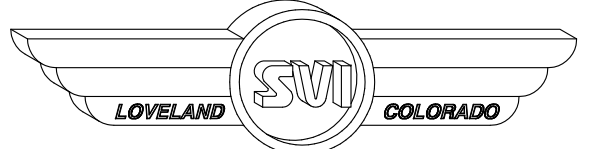

**LOVELAND SVI COLORADO**

**SVI FIRE & RESCUE TRUCKS**  
1511 E. 11th STREET, LOVELAND, CO 80537 PHONE 970-667-5146, FAX 970-667-3343

**SURPRISE FIRE DEPARTMENT**

BODY SIZE: <b>20' BODY</b>	UNIT TYPE: <b>HEAVY RESCUE</b>
BODY MATERIAL: <b>3/16" ALUMINUM</b>	TRUCK NO: <b>SVI #xxx</b>
CHASSIS TYPE: <b>SPARTAN</b>	WHEELBASE: <b>SEE DWG</b>
<b>GLADIATOR ELFD</b>	CAB TO AXLE: <b>SEE DWG</b>
<b>24" RR</b>	OVERALL LENGTH (OAL): <b>SEE DWG</b>
<b>THREE DOOR</b>	OVERALL WIDTH (OAW): <b>SEE DWG</b>
	OVERALL HEIGHT (OAH): <b>SEE DWG</b>

DRAWN BY: **HJR** DATE: **December 9, 2009** SCALE: **1/4" = 1'-0"**  
DRAWING NO: **Surprise\_AZ\_HZ\_20\_Prelim1** SHEET **1 OF 3**

PRELIMINARY DRAWING - FOR LAYOUT PURPOSES ONLY

REVISIONS			
REV	DESCRIPTION	DATE	BY

NOTE 1: Do not scale drawing. This drawing is for general truck configuration only. All items and dimensions shown are approximate and may vary with final production. The drawing may not provide illustration for all items in the specification. In all situations where the drawing may contradict the specifications, the specifications shall prevail. This drawing and all data herein are provided as confidential materials and shall not be reproduced without written consent of the manufacturer.

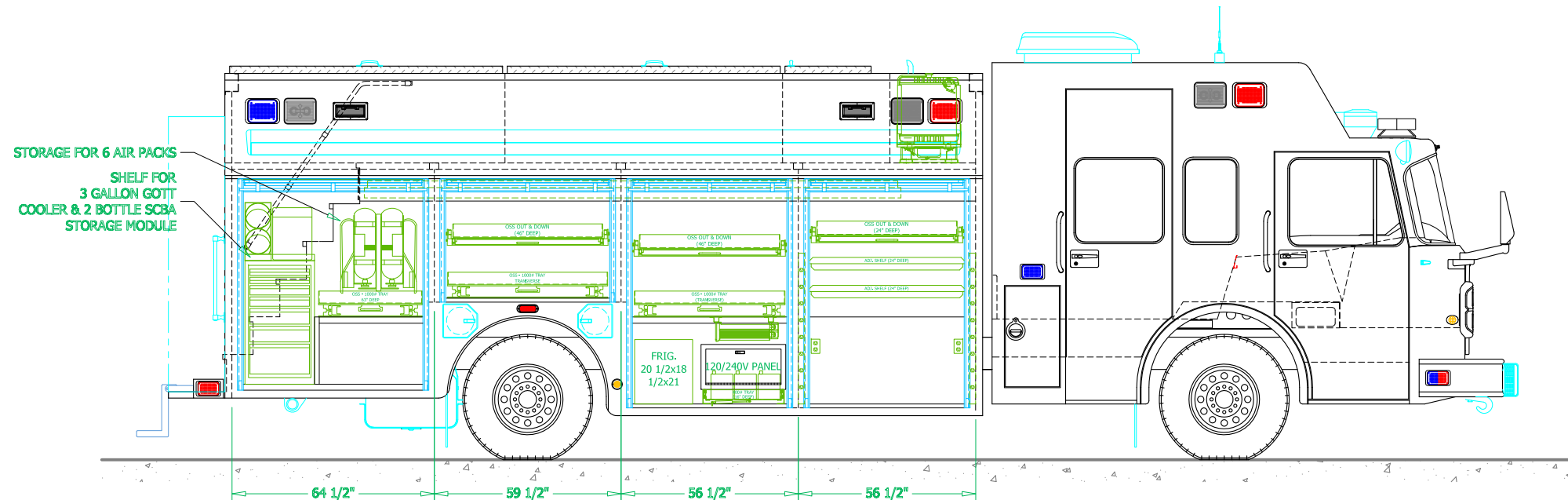
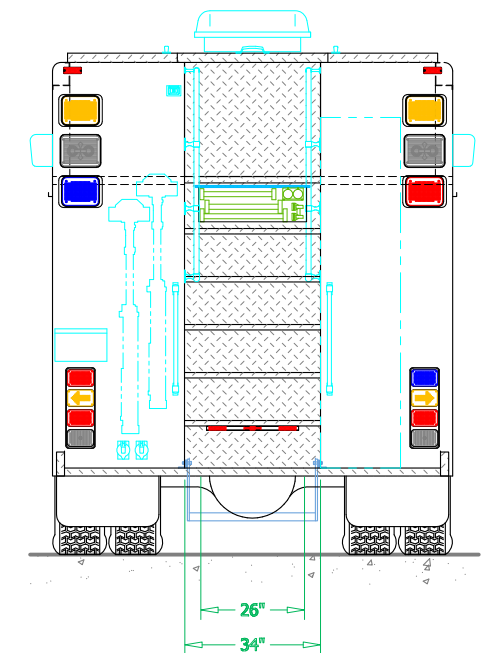
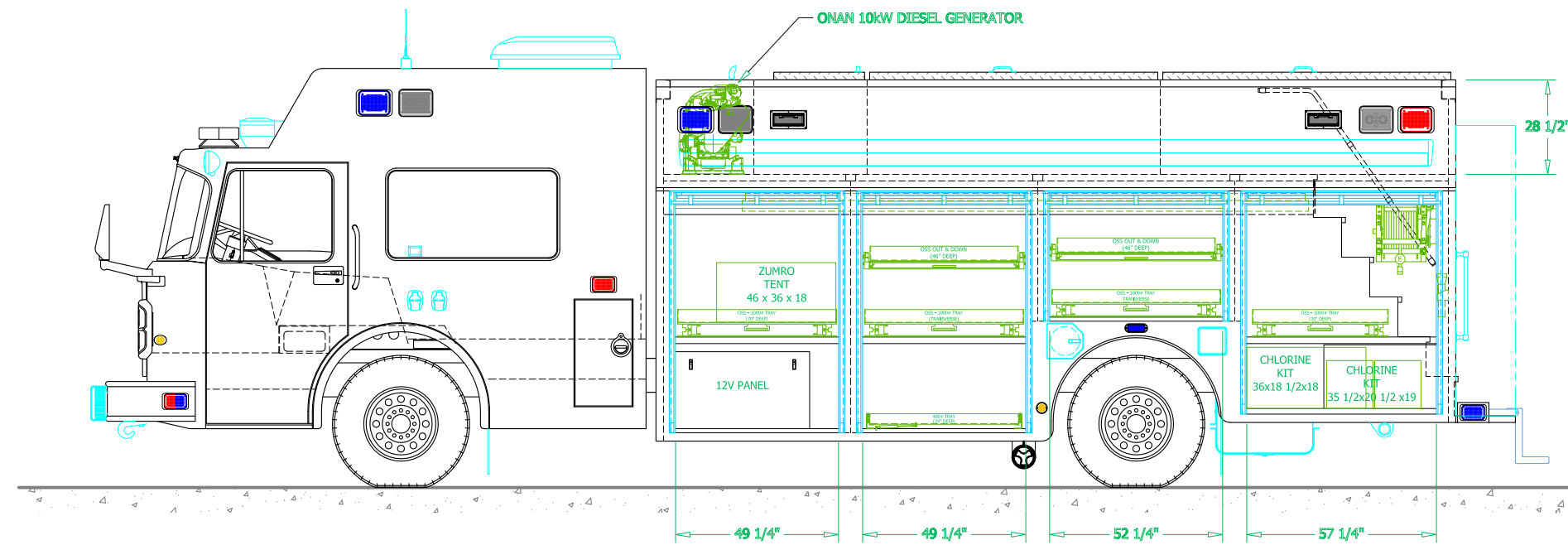
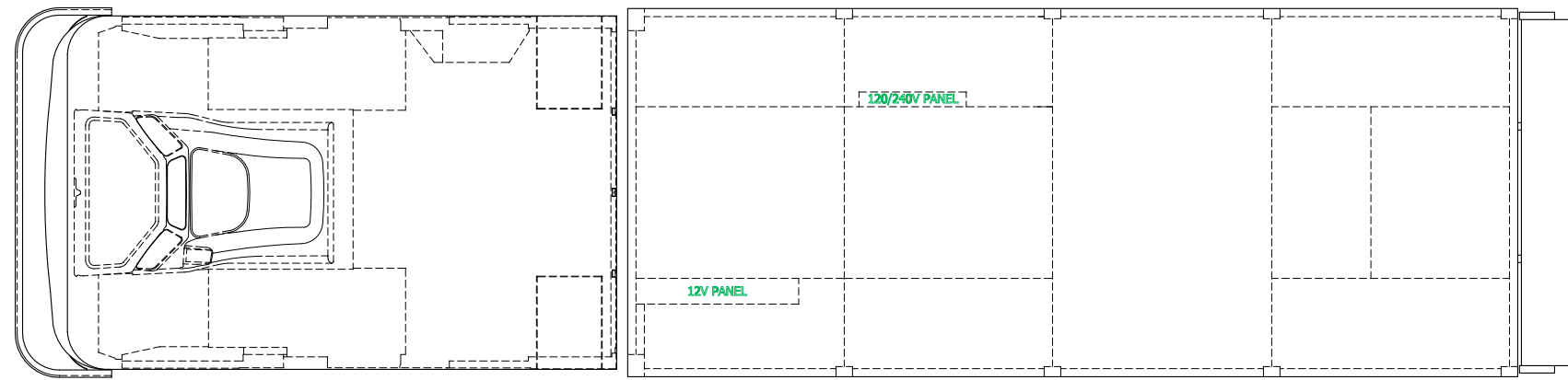

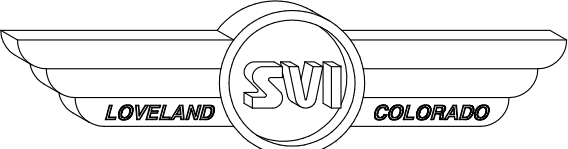

**LOVELAND SVI COLORADO**

**SVI FIRE & RESCUE TRUCKS**  
1511 E. 11th STREET, LOVELAND, CO 80537 PHONE 970-667-5146, FAX 970-667-3343

**SURPRISE FIRE DEPARTMENT**

DRAWN BY: HJR	DATE: December 9, 2009	SCALE: 1/4" = 1'-0"
DRAWING NO: Surprise_AZ_HZ_20_Prelim1		SHEET 2 OF 3

PRELIMINARY DRAWING - FOR LAYOUT PURPOSES ONLY

REVISIONS			
REV	DESCRIPTION	DATE	BY

PLAN VIEW  
CROSS-SECTION

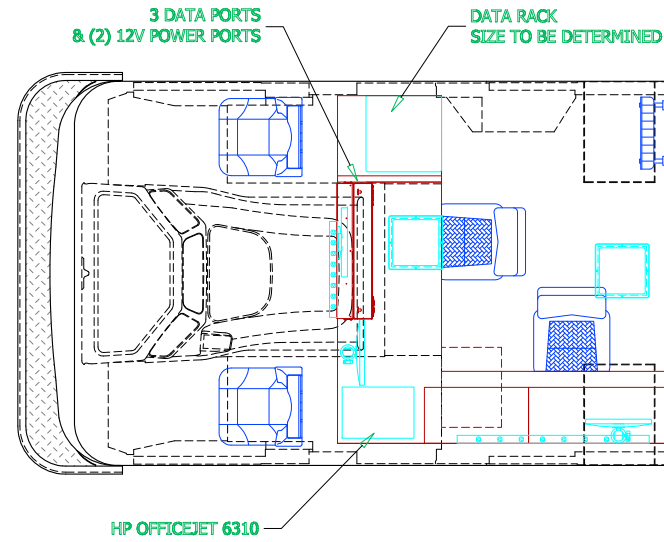

NOTE 1: Do not scale drawing. This drawing is for general truck configuration only. All items and dimensions shown are approximate and may vary with final production. The drawing may not provide illustration for all items in the specification. In all situations where the drawing may contradict the specifications, the specifications shall prevail. This drawing and all data herein are provided as confidential materials and shall not be reproduced without written consent of the manufacturer.

CURBSIDE INTERIOR  
CROSS-SECTION

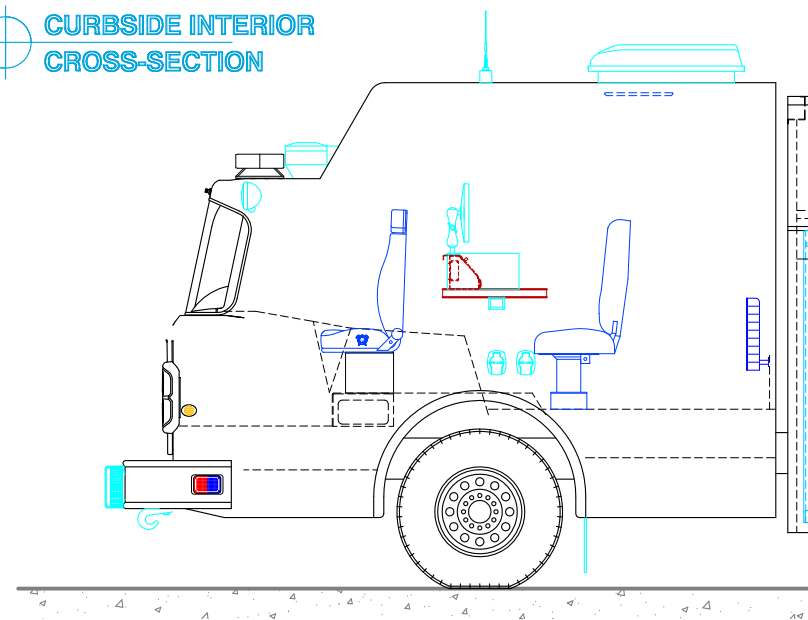

FRONT VIEW  
CROSS-SECTION

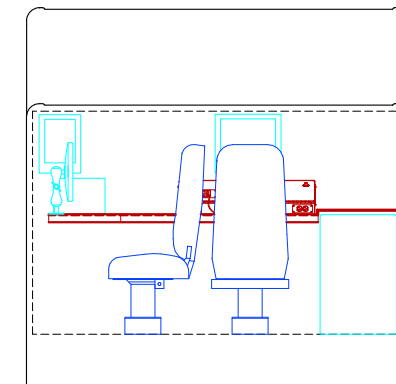

STREETSIDE INTERIOR  
CROSS-SECTION

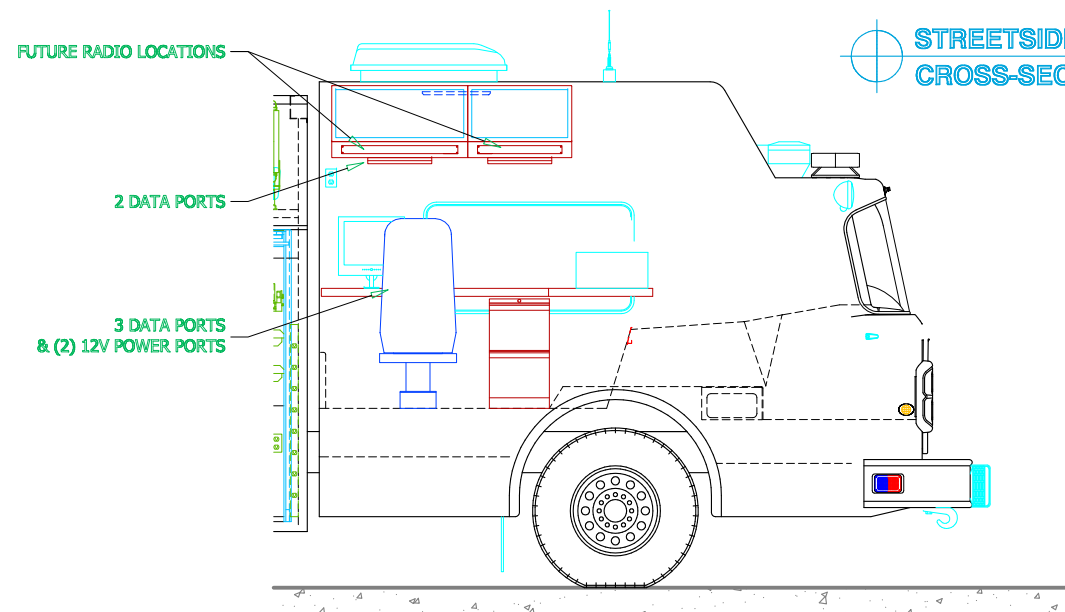

**SVI FIRE & RESCUE TRUCKS**  
1511 E. 11th STREET, LOVELAND, CO 80537 PHONE 970-667-5146, FAX 970-667-3343

**SURPRISE  
FIRE DEPARTMENT**

DRAWN BY: HJR	DATE: December 9, 2009	SCALE: 1/4" = 1'-0"
DRAWING NO: Surprise_AZ_HZ_20_Prelim1	SHEET 3 OF 3	