

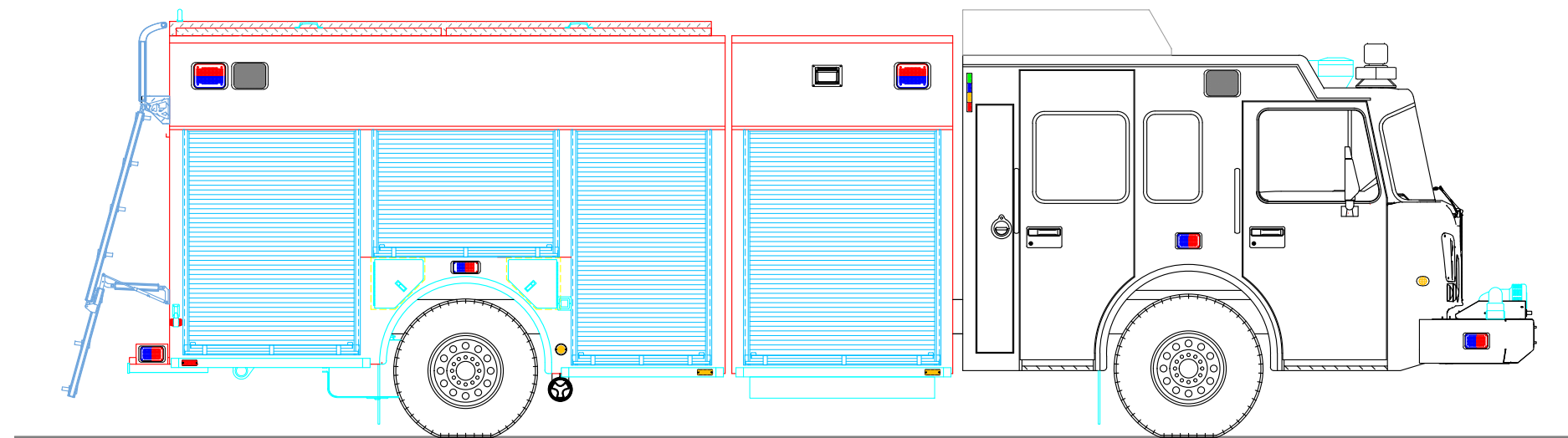
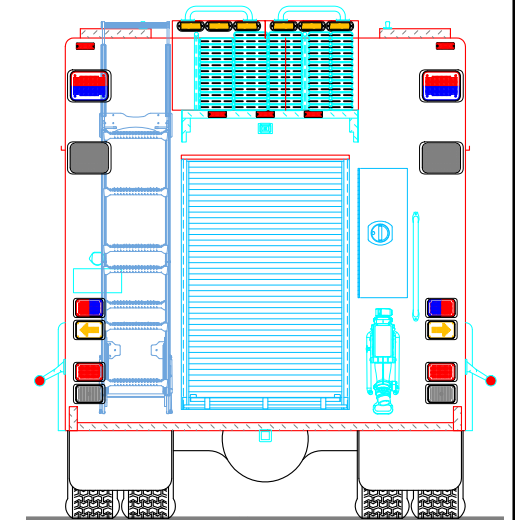
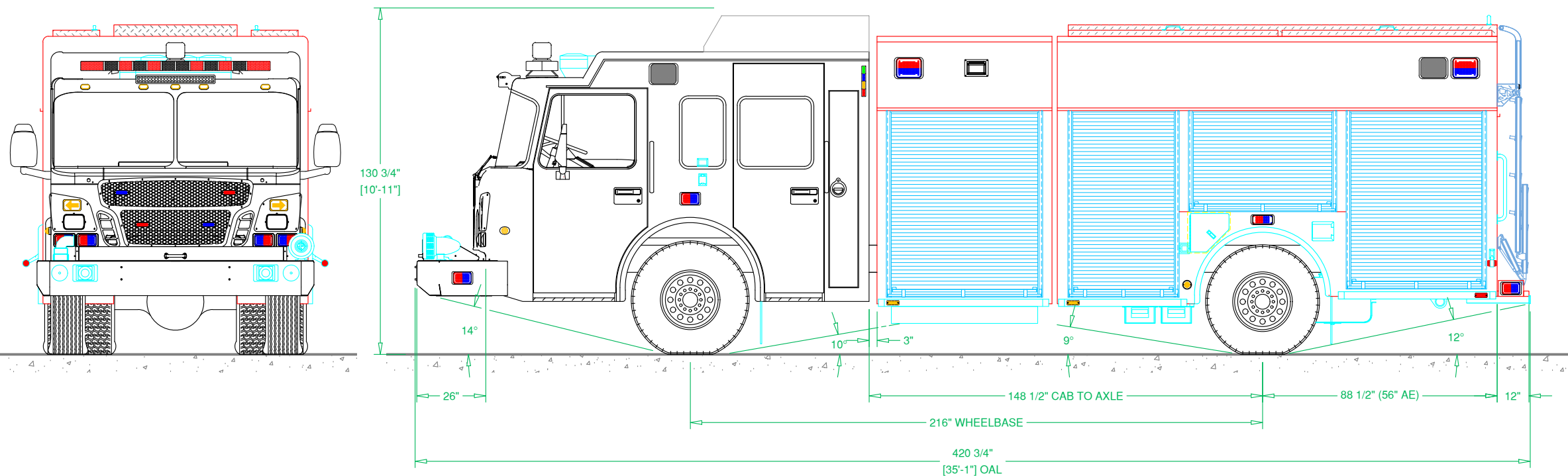
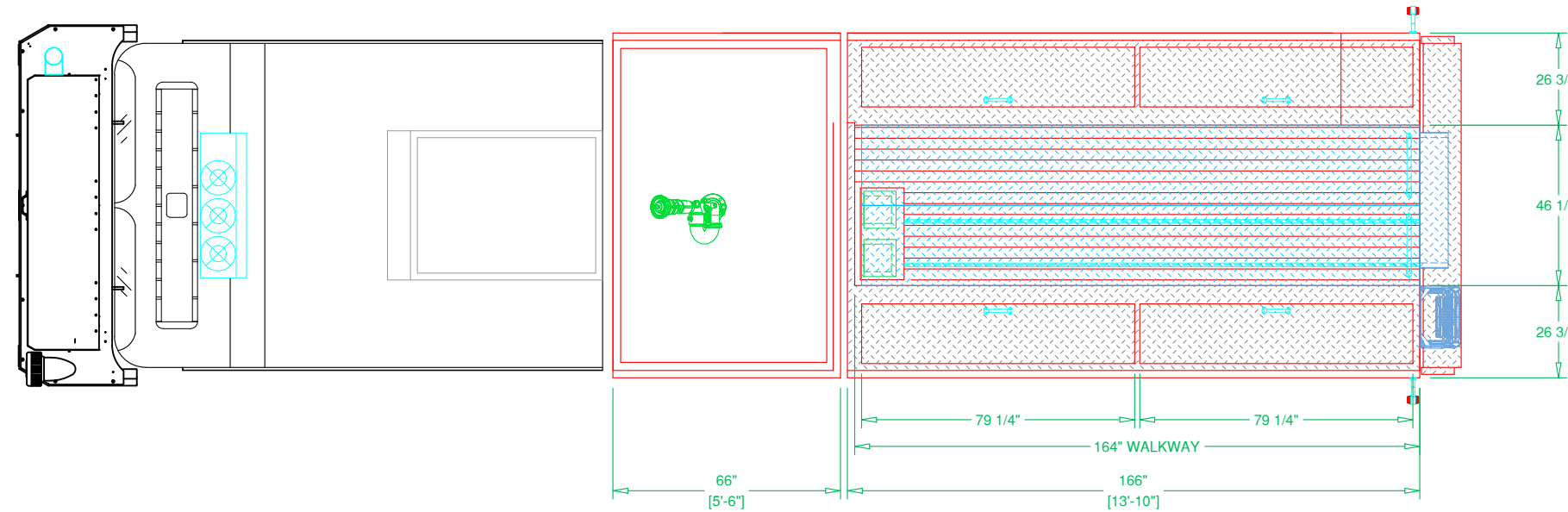

PRELIMINARY DRAWING - FOR LAYOUT PURPOSES ONLY

REVISIONS			
REV	DESCRIPTION	DATE	BY

NOTE 1: Do not scale drawing. This drawing is for general truck configuration only. All items and dimensions shown are approximate and may vary with final production. The drawing may not provide illustration for all items in the specification. In all situations where the drawing may contradict the specifications, the specifications shall prevail. This drawing and all data herein are provided as confidential materials and shall not be reproduced without written consent of the manufacturer.

NOTE 2: Chassis frame height will change due to axle characteristics, loading and tire dimensions which will effect the overall height dimension shown. Any overall height restrictions should take this into consideration and allow approximately 2-3 inches of tolerance.





**SVI**  
FORT COLLINS COLORADO

SVI FIRE & RESCUE TRUCKS  
3842 REDMAN DRIVE, FORT COLLINS, CO 80524 PHONE 970-297-7100, FAX 970-297-7099

## LARAMIE COUNTY FIRE DISTRICT #2

BODY SIZE: 14' BODY	UNIT TYPE: RESCUE PUMPER
BODY MATERIAL: 3/16" ALUMINUM	TRUCK NO: SVI #xxx
CHASSIS TYPE: SPARTAN	WHEELBASE: SEE DWG
METRO STAR LFD	CAB TO AXLE: SEE DWG
10" RR	OVERALL LENGTH (OAL): SEE DWG
FOUR DOOR	OVERALL WIDTH (OAW): SEE DWG
	OVERALL HEIGHT (OAH): SEE DWG

DRAWN BY: HJR      DATE: January 28, 2019      SCALE: 1/4" = 1'-0"

DRAWING NO: Laramie#2\_WY\_pm\_PreCon1      SHEET 1 OF 2

PRELIMINARY DRAWING - FOR LAYOUT PURPOSES ONLY

REVISIONS			
REV	DESCRIPTION	DATE	BY

NOTE 1: Do not scale drawing. This drawing is for general truck configuration only. All items and dimensions shown are approximate and may vary with final production. The drawing may not provide illustration for all items in the specifications. In all situations where the drawing may contradict the specifications, the specifications shall prevail. This drawing and all data herein are provided as confidential materials and shall not be reproduced without written consent of the manufacturer.

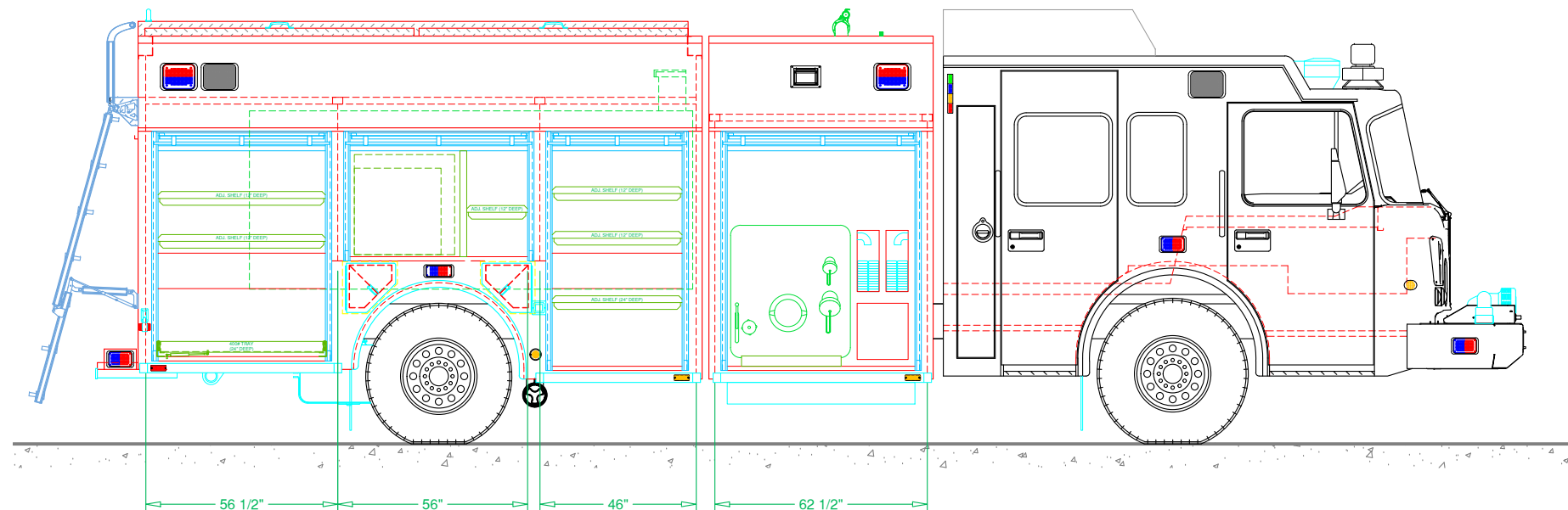
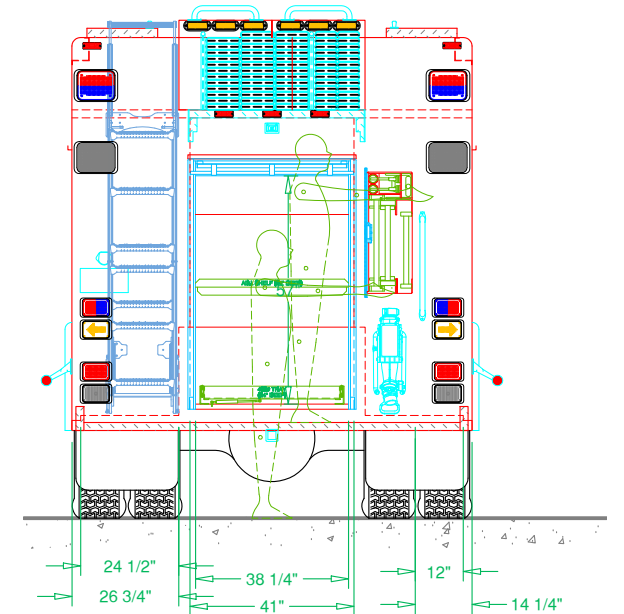
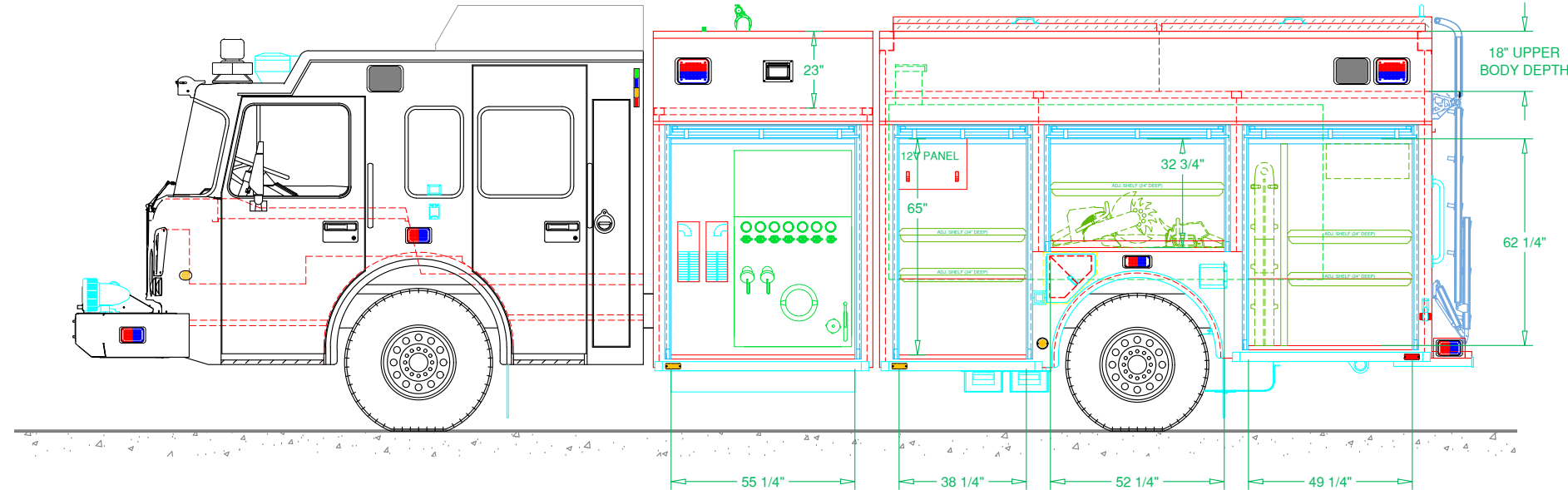
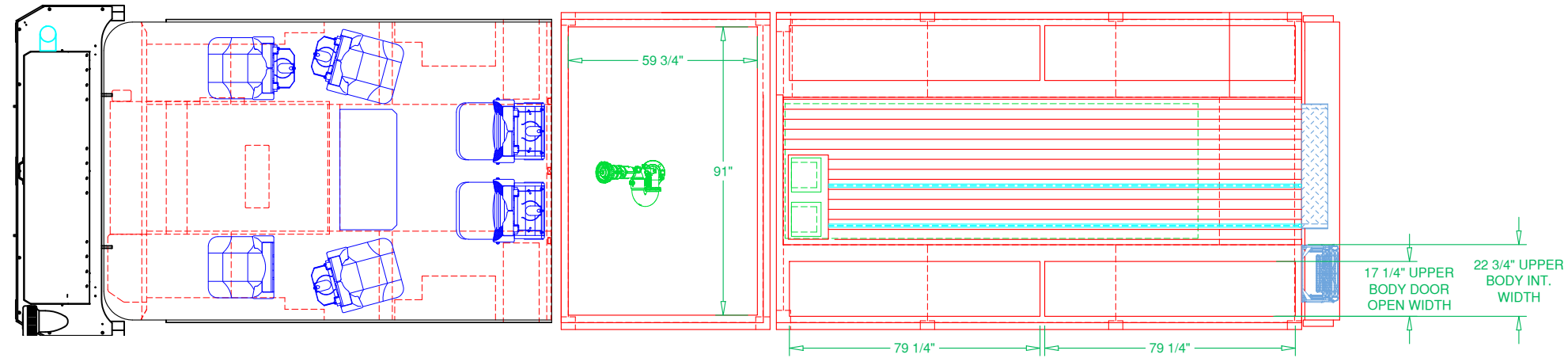



**SVI**

FORT COLLINS COLORADO

SVI FIRE & RESCUE TRUCKS  
3842 REDMAN DRIVE, FORT COLLINS, CO 80524 PHONE 970-297-7100, FAX 970-297-7099

**LARAMIE COUNTY  
FIRE DISTRICT #2**

DRAWN BY: HJR	DATE: Jan. 28, 19	SCALE: 1/4" = 1'-0"
DRAWING NO: Laramie#2_WY_pm_PreCon1	SHEET 2 OF 2	