

PRELIMINARY DRAWING - FOR LAYOUT PURPOSES ONLY

REVISIONS			
REV	DESCRIPTION	DATE	BY

NOTE 1: Do not scale drawing. This drawing is for general truck configuration only. All items and dimensions shown are approximate and may vary with final production. The drawing may not provide illustration for all items in the specification. In all situations where the drawing may contradict the specifications, the specifications shall prevail. This drawing and all data herein are provided as confidential materials and shall not be reproduced without written consent of the manufacturer.

NOTE 2: Chassis frame height will change due to axle characteristics, loading and tire dimensions which will effect the overall height dimension shown. Any overall height restrictions should take this into consideration and allow approximately 2-3 inches of tolerance.

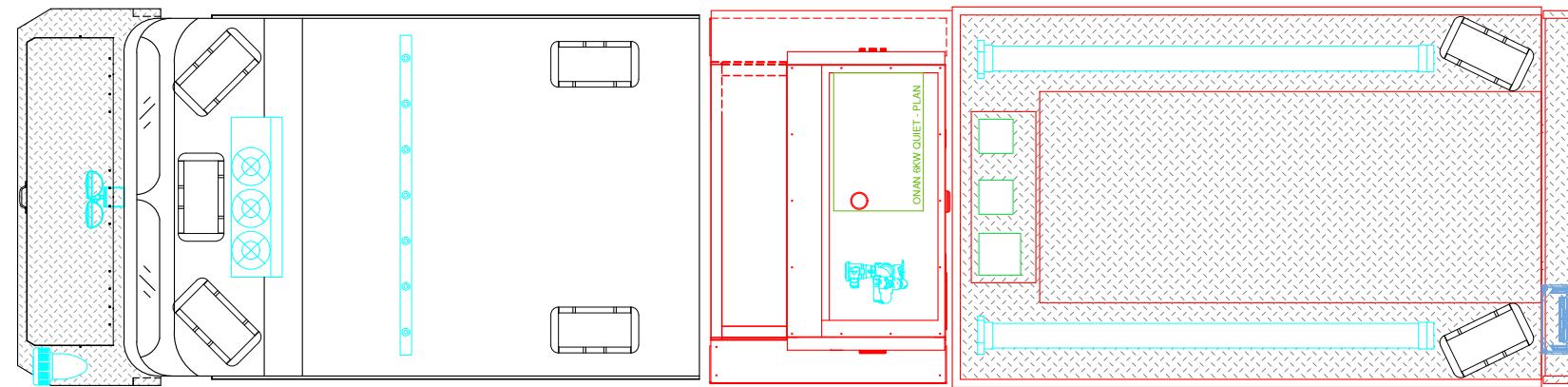

155"
[12'-11"] (12' BODY)
(4) WHELEN PIONEER PCPSM2C SERIES SCENE LIGHTS (2 EACH SIDE)

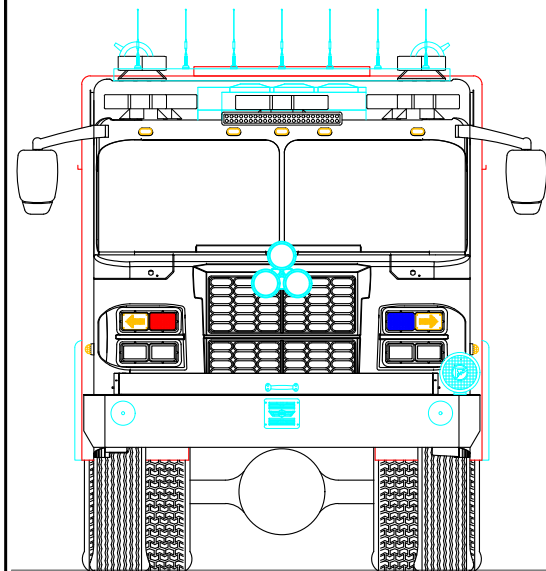

133 3/4"
[11'-2"] OAH

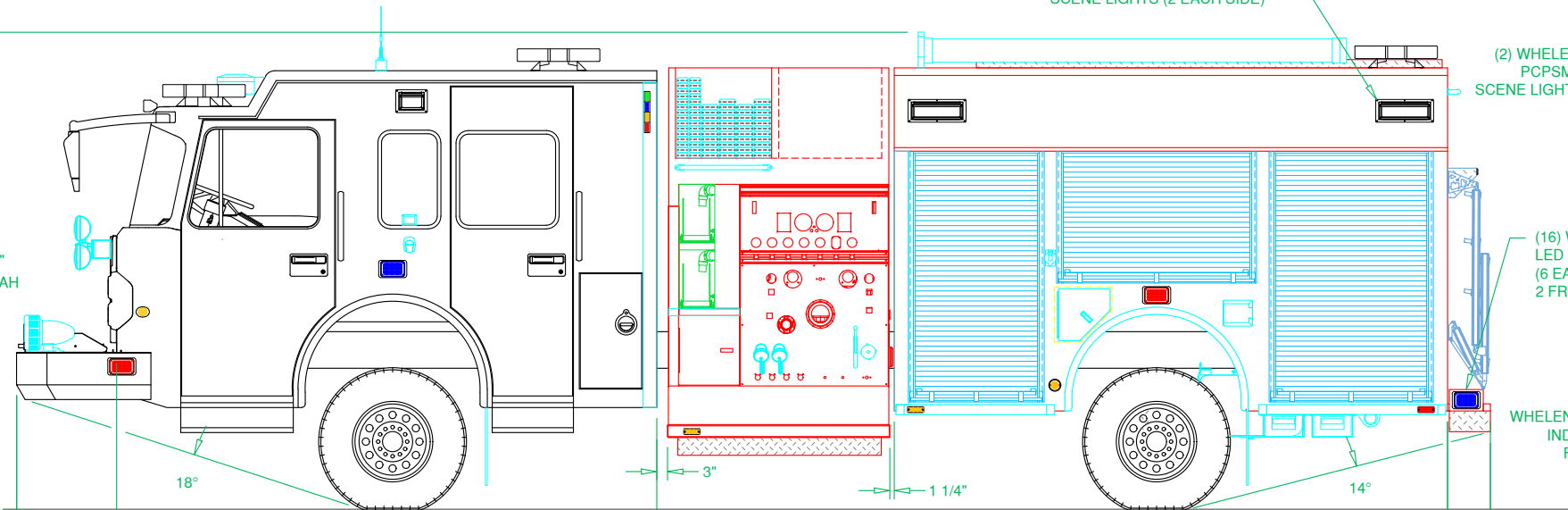

18°
28"
140" CAB TO AXLE
214" WHEELBASE
412 3/4"
[34'-5"] OAL
1 1/4"
81 1/2"
12"
14°

(2) WHELEN PIONEER PCPSM1C SERIES SCENE LIGHTS (2 REAR)

(16) WHELEN C6 SERIES LED WARNING LIGHTS (6 EACH SIDE, 2 FRONT, 2 REAR)

WHELEN C6 LED SERIES INDIVIDUAL LIGHTS FOR TAIL LIGHTS

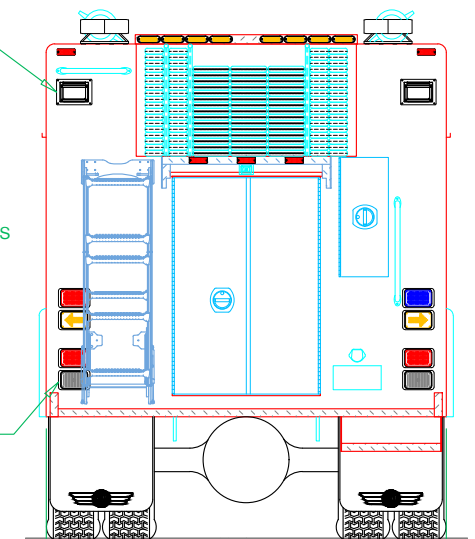

100"
[8'-4"] OAW

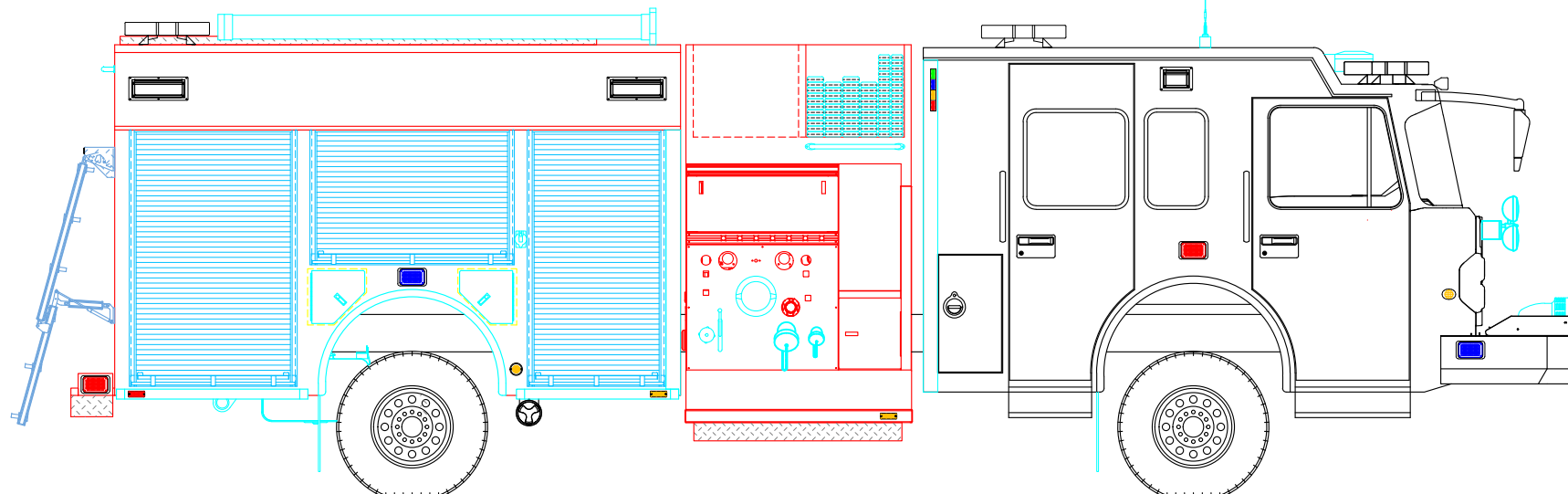

SVI FIRE & RESCUE TRUCKS
3842 REDMAN DRIVE, FORT COLLINS, CO 80524 PHONE 970-297-7100, FAX 970-297-7099

**CAMPBELL COUNTY
FIRE DEPARTMENT**

BODY SIZE: 12' BODY	UNIT TYPE: PUMPER
BODY MATERIAL: 3/16" ALUMINUM	TRUCK NO: SVI #xxx
CHASSIS TYPE: SPARTAN	WHEELBASE: SEE DWG
METRO STAR ELFD	CAB TO AXLE: SEE DWG
10" RR	OVERALL LENGTH (OAL): SEE DWG
FOUR DOOR	OVERALL WIDTH (OAW): SEE DWG
	OVERALL HEIGHT (OAH): SEE DWG
DRAWN BY: HJR	DATE: February 20, 2019
DRAWING NO: CampbellCo WY pm PreCon1	SCALE: 1/4" = 1'-0"
	SHEET 1 OF 2

PRELIMINARY DRAWING - FOR LAYOUT PURPOSES ONLY

REVISIONS			
REV	DESCRIPTION	DATE	BY

NOTE 1: Do not scale drawing. This drawing is for general truck configuration only. All items and dimensions shown are approximate and may vary with final production. The drawing may not provide illustration for all items in the specification. In all situations where the drawing may contradict the specifications, the specifications shall prevail. This drawing and all data herein are provided as confidential materials and shall not be reproduced without written consent of the manufacturer.

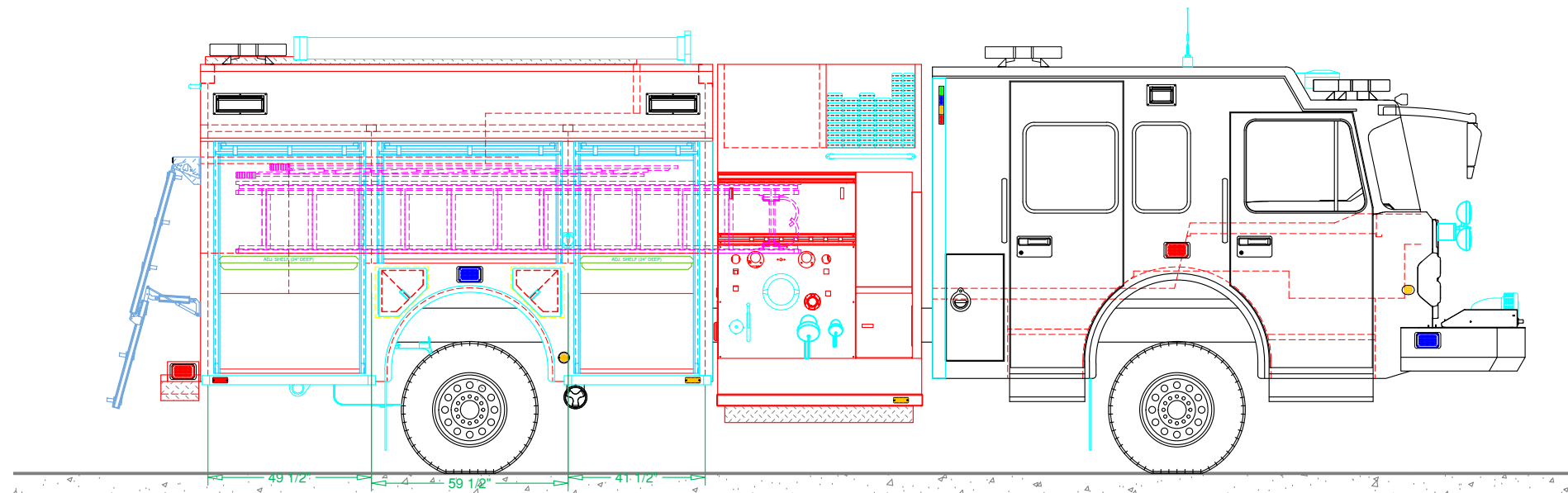
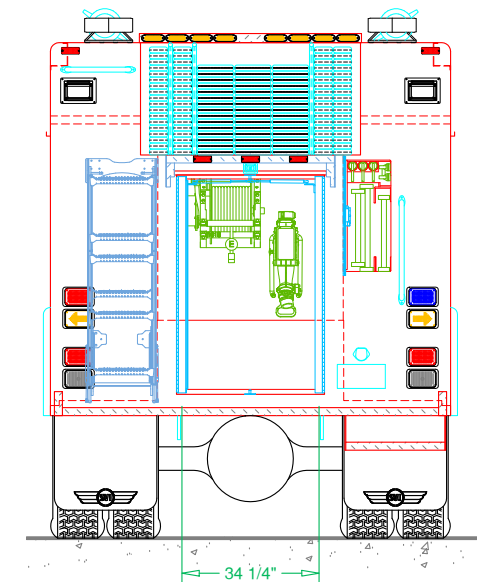
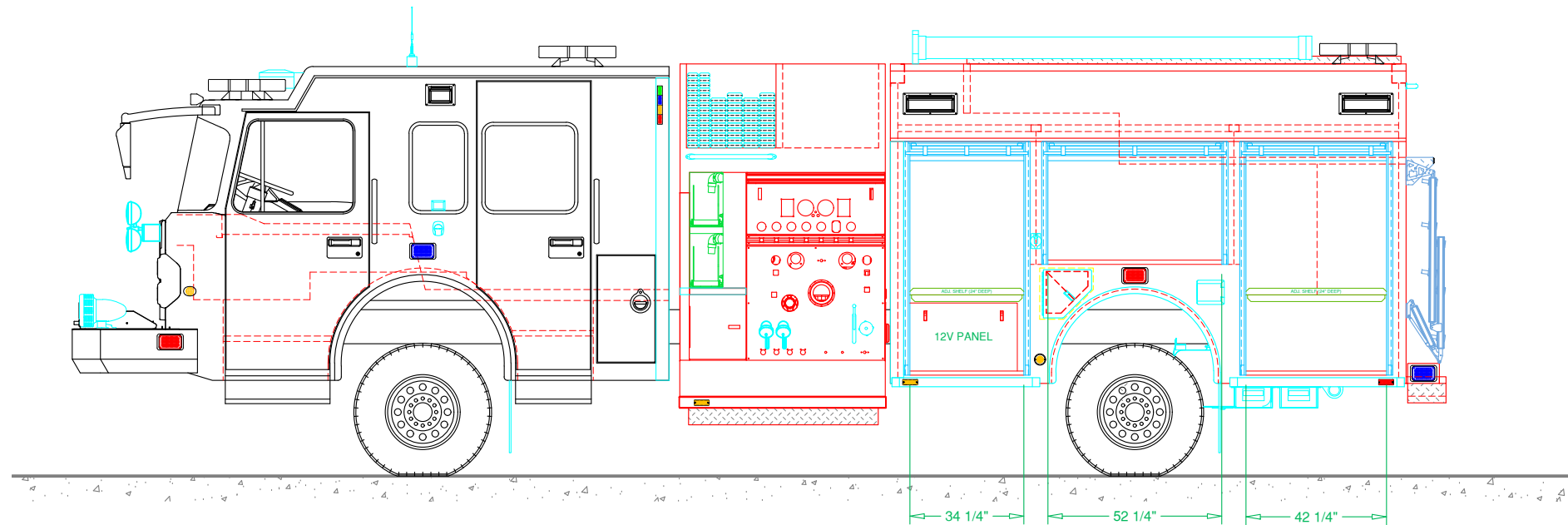
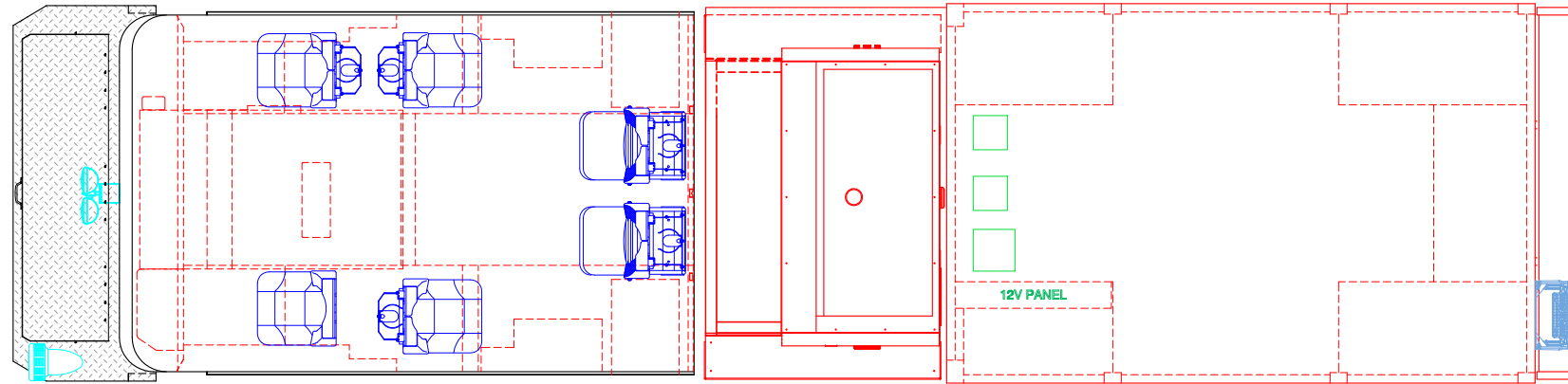



SVI FIRE & RESCUE TRUCKS
3842 REDMAN DRIVE, FORT COLLINS, CO 80524 PHONE 970-297-7100, FAX 970-297-7099

**CAMPBELL COUNTY
FIRE DEPARTMENT**

DRAWN BY: HJR	DATE: Feb. 20, 19	SCALE: 1/4" = 1'-0"
DRAWING NO: CampbellCo WY pm PreCon1	SHEET 2 OF 2	