



Upper Pine River Fire Protection District, Bayfield (CO) Water Supply #1224

Chassis

Cab: Freightliner M2 2-Door
Engine: Cummins L9
Transmission: Allison 3000 EVS
Wheelbase: 183"

Body

Material: Aluminum
Body Length: 14'
Overall Height: 10' - 8"
Overall Length: 24' - 8"

Features

OnScene Solutions Access PRO LED Lighting
2,000 Gallon Poly Water Tank
500 gpm Waterous CLVK Fire Pump
2,940 gpm Newton Kwik-Dump Valve
2,100 Gallon Fol-Da-Tank Portable Water Supply Tank
(2) 10' Hard Suction Hoses
Hose Bed Storage
Zico PTS-HA Quic-Lift System
Ziamatic Ladder Assist System
(1) 24' 2-Section Ladder
(1) 14' Roof Ladder

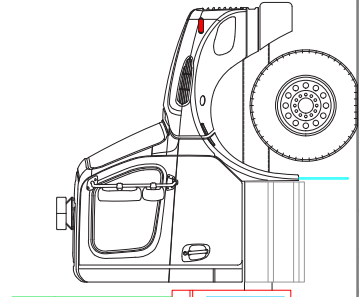
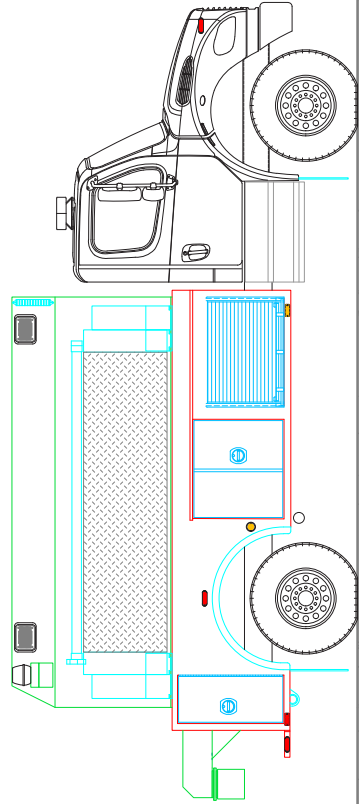
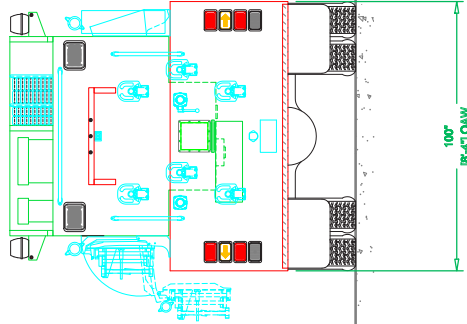
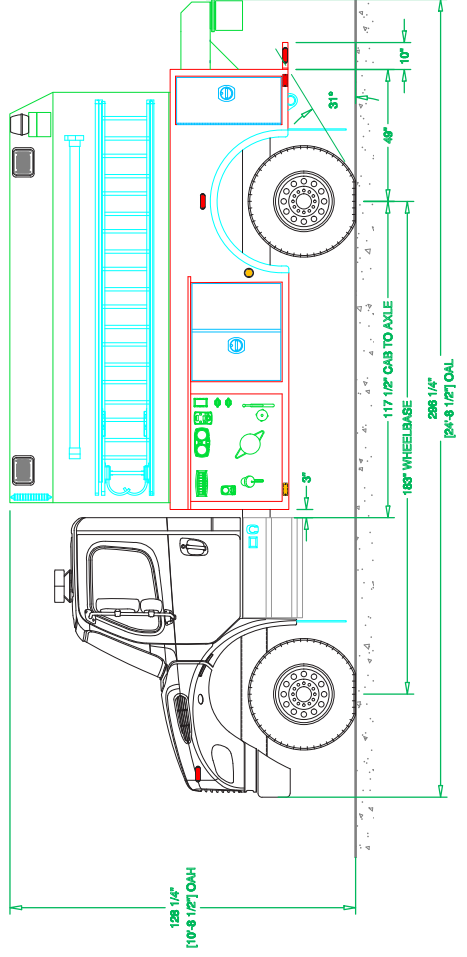
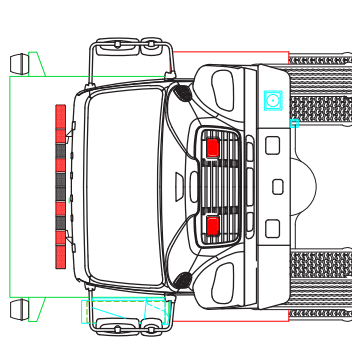
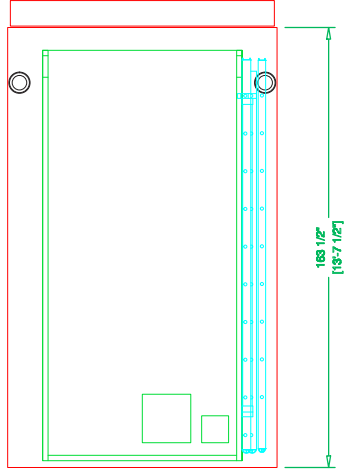
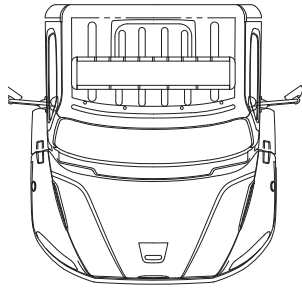

See more at svitrucks.com