

Chassis: Spartan
 Engine: TBD
 Transmission: TBD
 Axles: ONE FRONT | ONE REAR
 Model: FC94 LFD
 Generator: MARATHON 40KW
 Door Framed Openings

Compartment	Door Framed Opening
SS1	N/A
SS2	64.5"
SS3	64.5"
SS4	70.5"
SS5	N/A
CS1	62.0"
CS2	64.5"
CS3	64.5"
CS4	70.5"
CS5	N/A
R1	49.5"

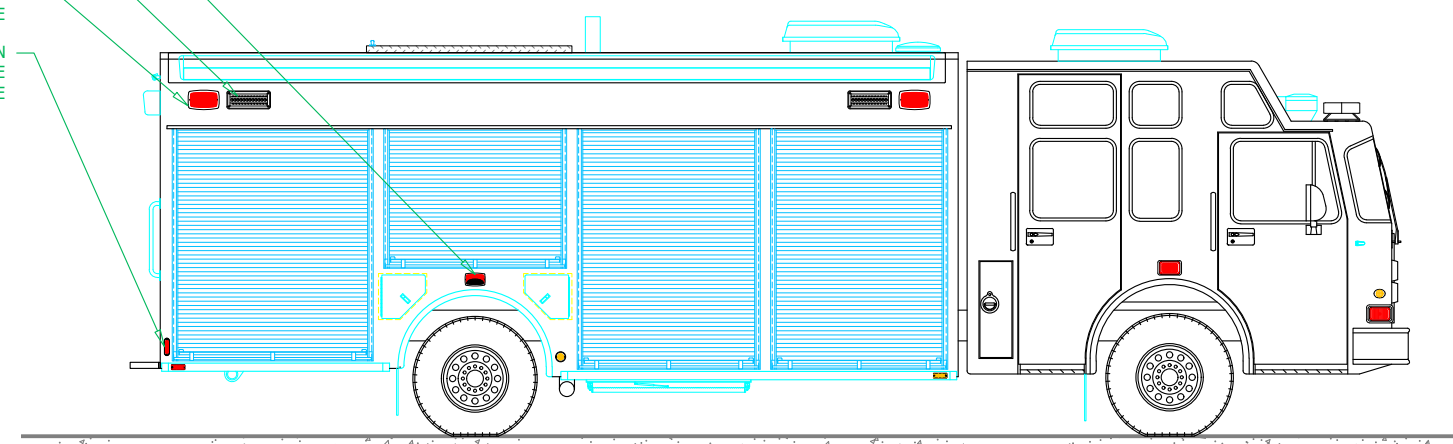
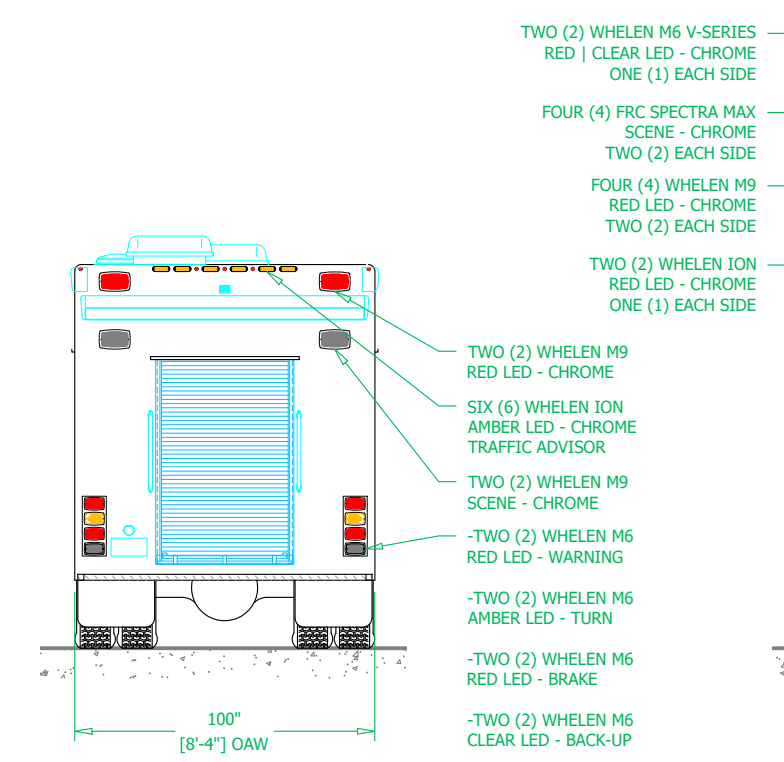
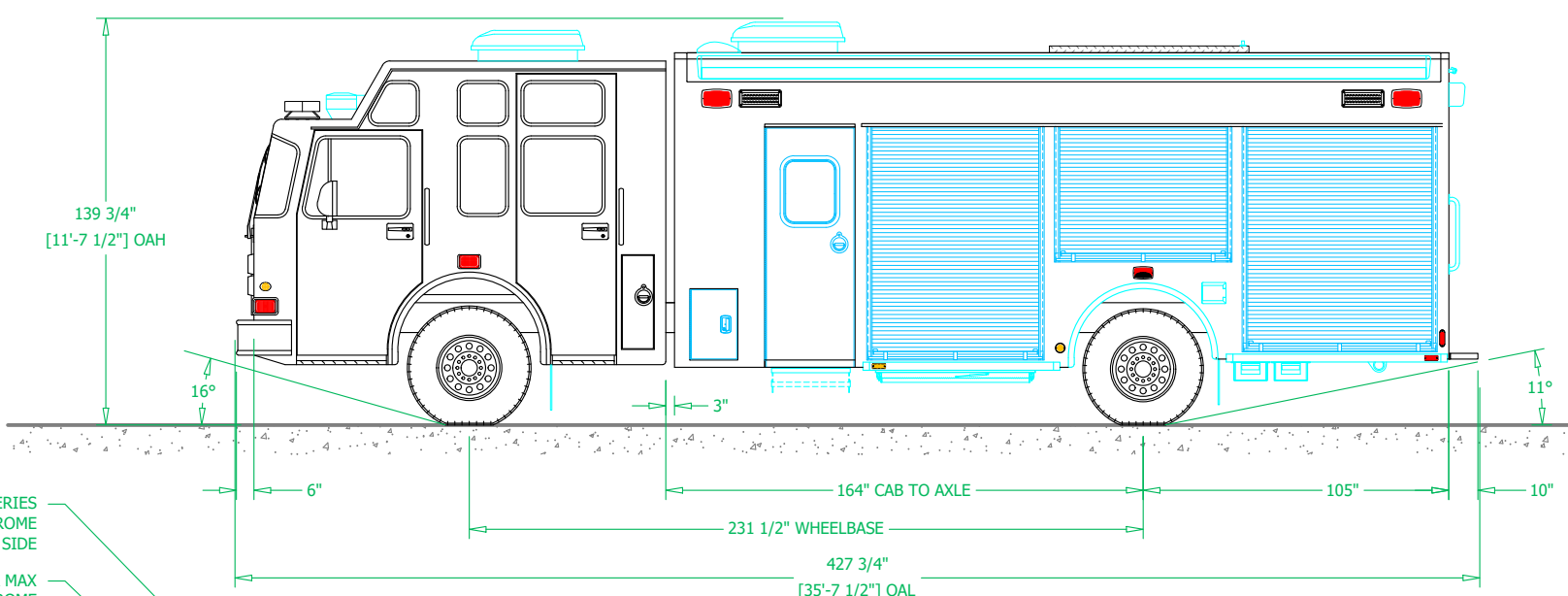
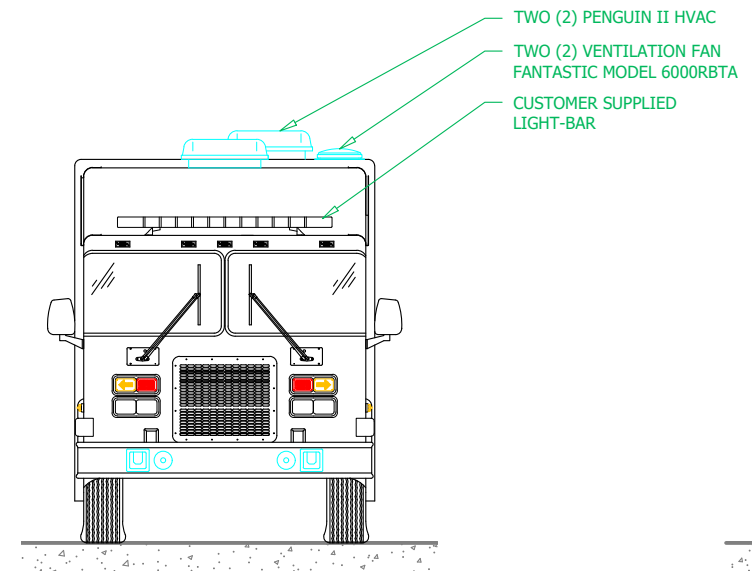
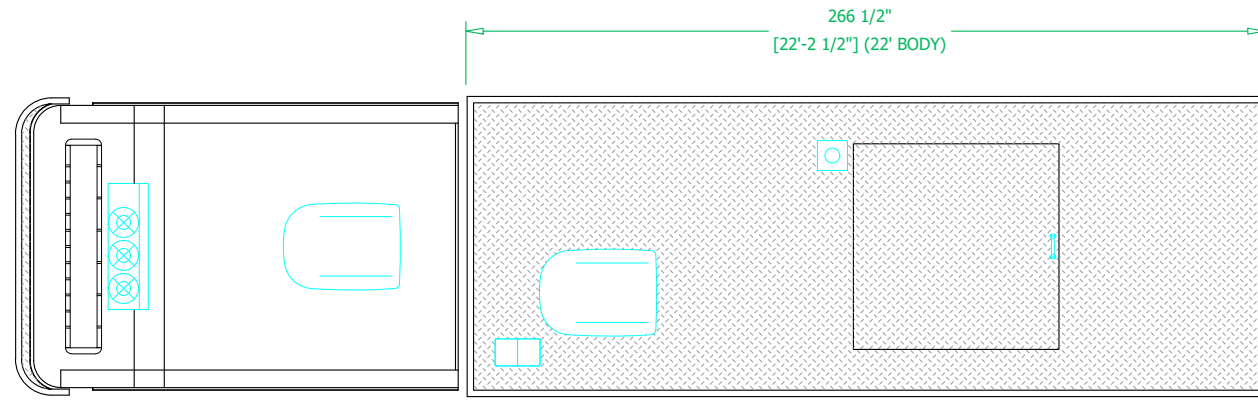

SPECIAL NOTES:

CUSTOMER
 THIS DRAWING IS A CLOSE APPROXIMATION OF YOUR FIRE APPARATUS. IN ALL CASES WHERE THE DRAWING AND THE WRITTEN SPECIFICATION DIFFER, THE SPECIFICATION SHALL PREVAIL. PLEASE WORK WITH YOUR DEALER TO ASSURE THAT THE WRITTEN SPECIFICATION REPRESENTS WHAT YOU WANT IN YOUR FINISHED PRODUCT. SPARTAN EMERGENCY RESPONSE BUILDS TO THE WRITTEN SPECIFICATION, NOT THE DRAWING TO ASSURE THAT YOUR NEEDS ARE MET.

PROPRIETARY AND CONFIDENTIAL
 THE INFORMATION CONTAINED IN THIS DRAWING IS THE SOLE PROPERTY OF SPARTAN EMERGENCY RESPONSE. ANY REPRODUCTION IN PART OR AS A WHOLE WITHOUT THE WRITTEN PERMISSION OF SPARTAN EMERGENCY RESPONSE IS PROHIBITED. SPARTAN MOTORS USA, INC. D/B/A SPARTAN EMERGENCY RESPONSE.

Rev	Date	Description	Name

Scale: NOT TO SCALE

Customer: FRESNO FIRE DEPARTMENT

Truck Number: #1265	Dealer: FAS
------------------------	----------------

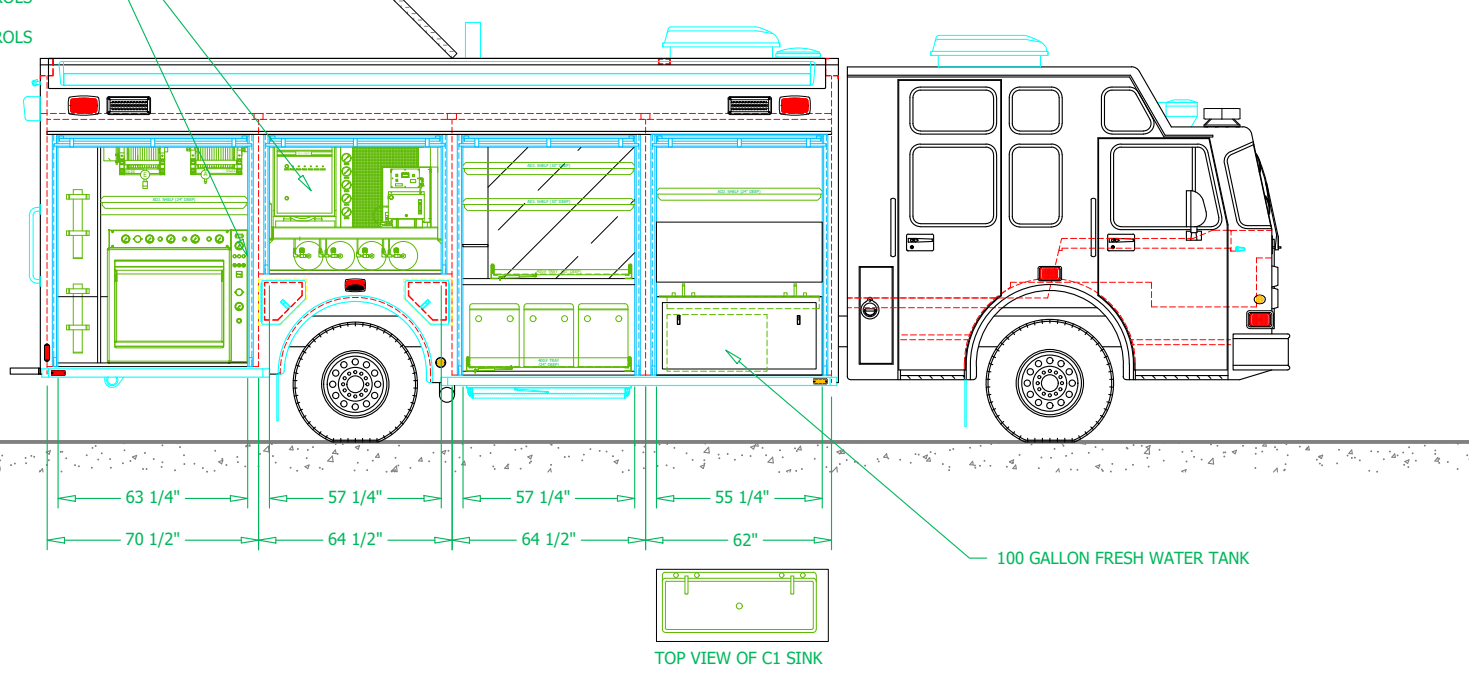
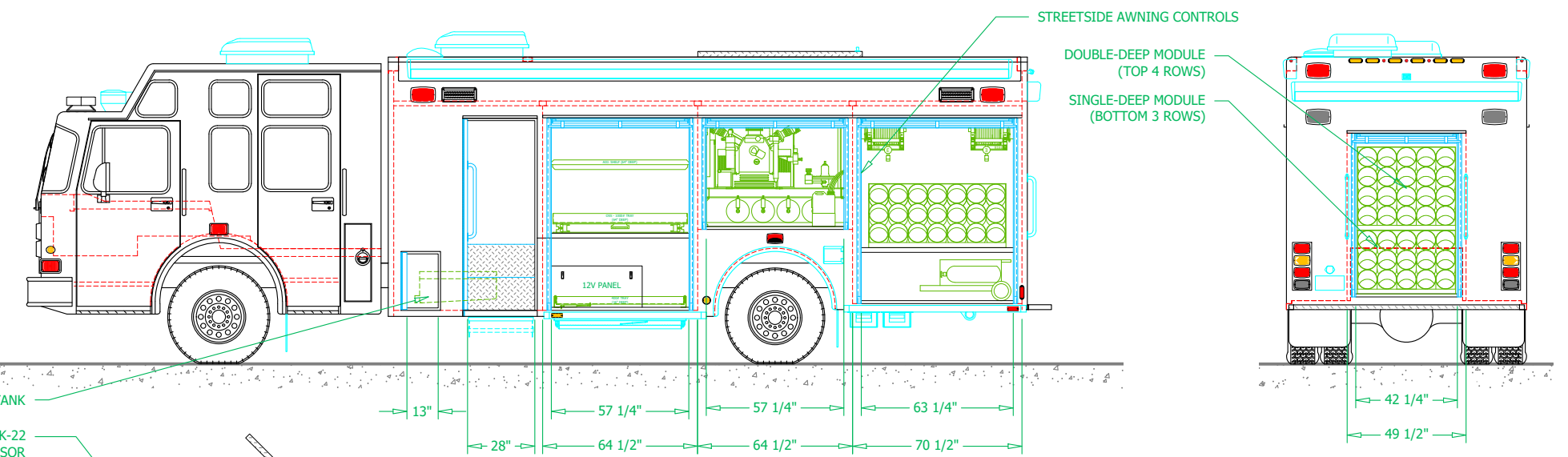
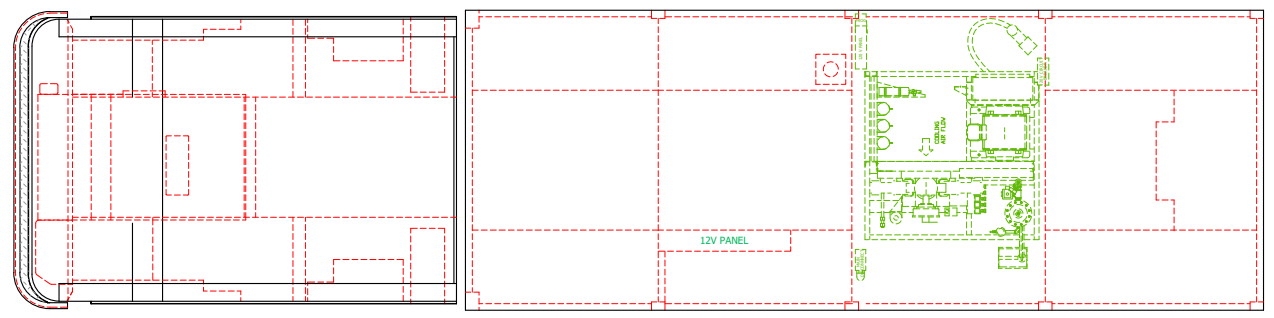
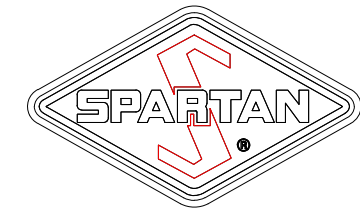

Chassis: Spartan

Engine: TBD

Transmission: TBD

Axles: ONE FRONT | ONE REAR

Model: FC94 LFD

Generator: MARATHON 40KW

Door Framed Openings

Compartment	Door Framed Opening
SS1	N/A
SS2	64.5"
SS3	64.5"
SS4	70.5"
SS5	N/A
CS1	62.0"
CS2	64.5"
CS3	64.5"
CS4	70.5"
CS5	N/A
R1	49.5"

SPECIAL NOTES:

CUSTOMER

THIS DRAWING IS A CLOSE APPROXIMATION OF YOUR FIRE APPARATUS. IN ALL CASES WHERE THE DRAWING AND THE WRITTEN SPECIFICATION DIFFER, THE SPECIFICATION SHALL PREVAIL. PLEASE WORK WITH YOUR DEALER TO ASSURE THAT THE WRITTEN SPECIFICATION REPRESENTS WHAT YOU WANT IN YOUR FINISHED PRODUCT. SPARTAN EMERGENCY RESPONSE BUILDS TO THE WRITTEN SPECIFICATION, NOT THE DRAWING TO ASSURE THAT YOUR NEEDS ARE MET.

PROPRIETARY AND CONFIDENTIAL

THE INFORMATION CONTAINED IN THIS DRAWING IS THE SOLE PROPERTY OF SPARTAN EMERGENCY RESPONSE. ANY REPRODUCTION IN PART OR AS A WHOLE WITHOUT THE WRITTEN PERMISSION OF SPARTAN EMERGENCY RESPONSE IS PROHIBITED. SPARTAN MOTORS USA, INC. D/B/A SPARTAN EMERGENCY RESPONSE.

Rev	Date	Description	Name
Scale: NOT TO SCALE			
Customer:		FRESNO FIRE DEPARTMENT	
Truck Number:		Dealer:	
#1265		FAS	

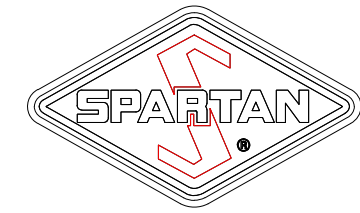

PLAN VIEW
CROSS-SECTION

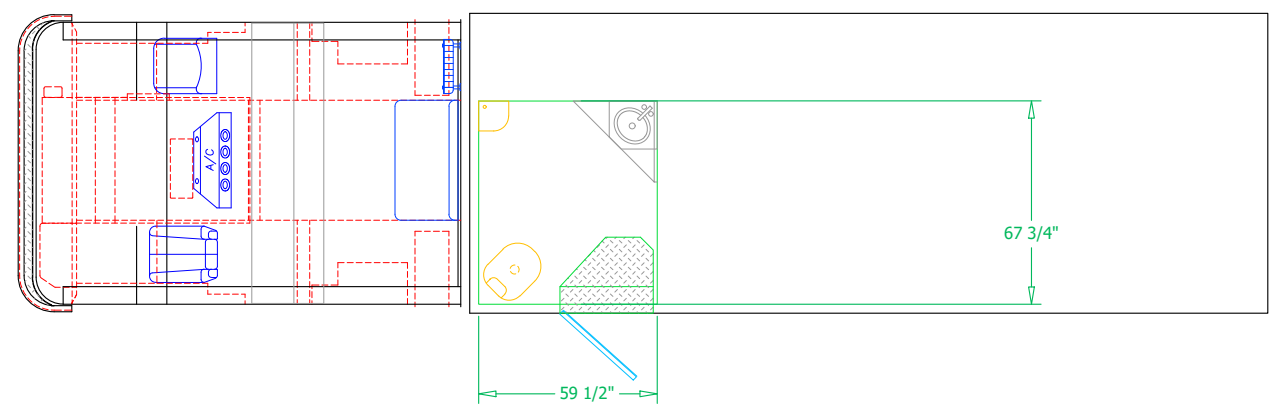

WALK-IN
CROSS-SECTION

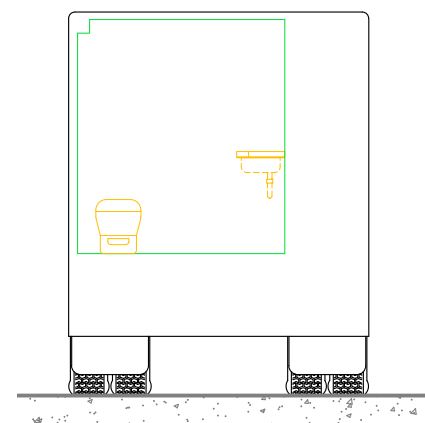

CURBSIDE INTERIOR
CROSS-SECTION

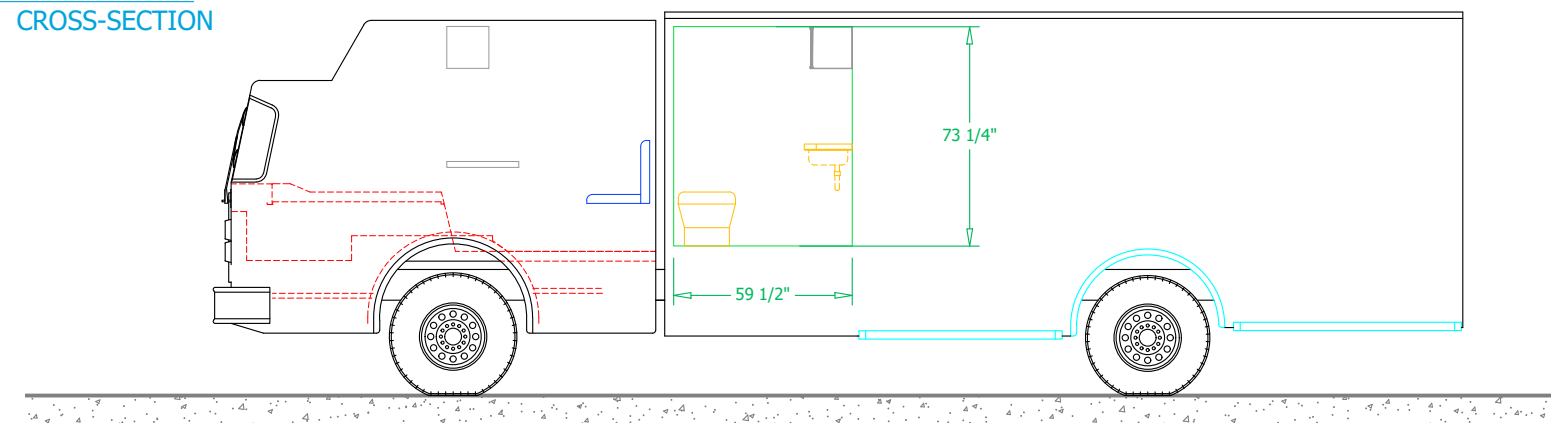

STREETSIDE INTERIOR
CROSS-SECTION

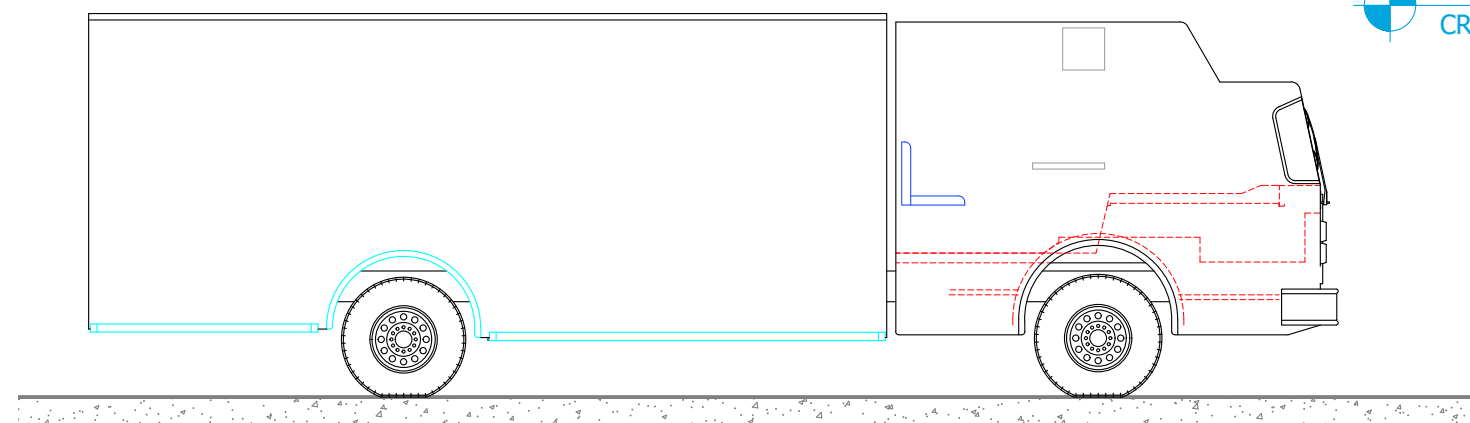

Chassis: Spartan	
Engine: TBD	
Transmission: TBD	
Axles: ONE FRONT ONE REAR	
Model: FC94 LFD	
Generator: MARATHON 40KW	
Door Framed Openings	
Compartment	Door Framed Opening
SS1	N/A
SS2	64.5"
SS3	64.5"
SS4	70.5"
SS5	N/A
CS1	62.0"
CS2	64.5"
CS3	64.5"
CS4	70.5"
CS5	N/A
R1	49.5"

SPECIAL NOTES:

CUSTOMER
THIS DRAWING IS A CLOSE APPROXIMATION OF YOUR FIRE APPARATUS. IN ALL CASES WHERE THE DRAWING AND THE WRITTEN SPECIFICATION DIFFER, THE SPECIFICATION SHALL PREVAIL. PLEASE WORK WITH YOUR DEALER TO ASSURE THAT THE WRITTEN SPECIFICATION REPRESENTS WHAT YOU WANT IN YOUR FINISHED PRODUCT. SPARTAN EMERGENCY RESPONSE BUILDS TO THE WRITTEN SPECIFICATION, NOT THE DRAWING TO ASSURE THAT YOUR NEEDS ARE MET.

PROPRIETARY AND CONFIDENTIAL
THE INFORMATION CONTAINED IN THIS DRAWING IS THE SOLE PROPERTY OF SPARTAN EMERGENCY RESPONSE. ANY REPRODUCTION IN PART OR AS A WHOLE WITHOUT THE WRITTEN PERMISSION OF SPARTAN EMERGENCY RESPONSE IS PROHIBITED. SPARTAN MOTORS USA, INC. D/B/A SPARTAN EMERGENCY RESPONSE.

Rev	Date	Description	Name
Scale: NOT TO SCALE			
Customer: FRESNO FIRE DEPARTMENT			
Truck Number: #1265		Dealer: FAS	