

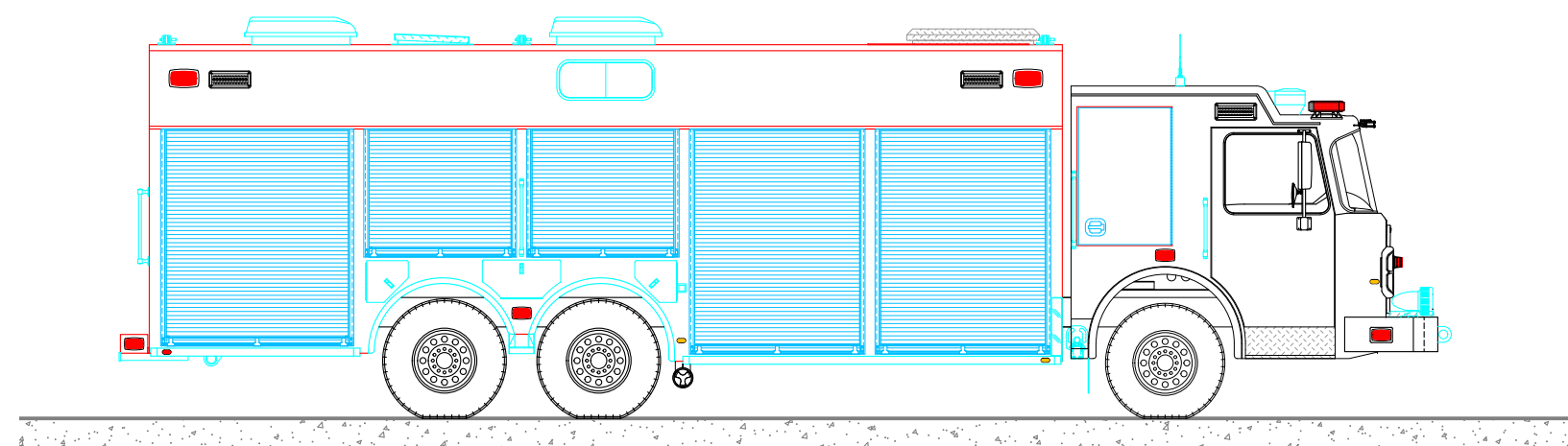
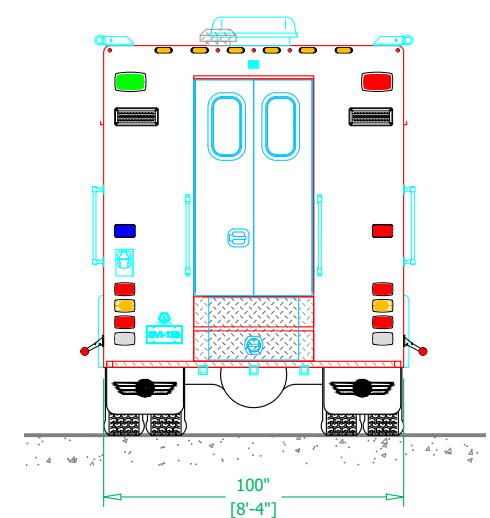
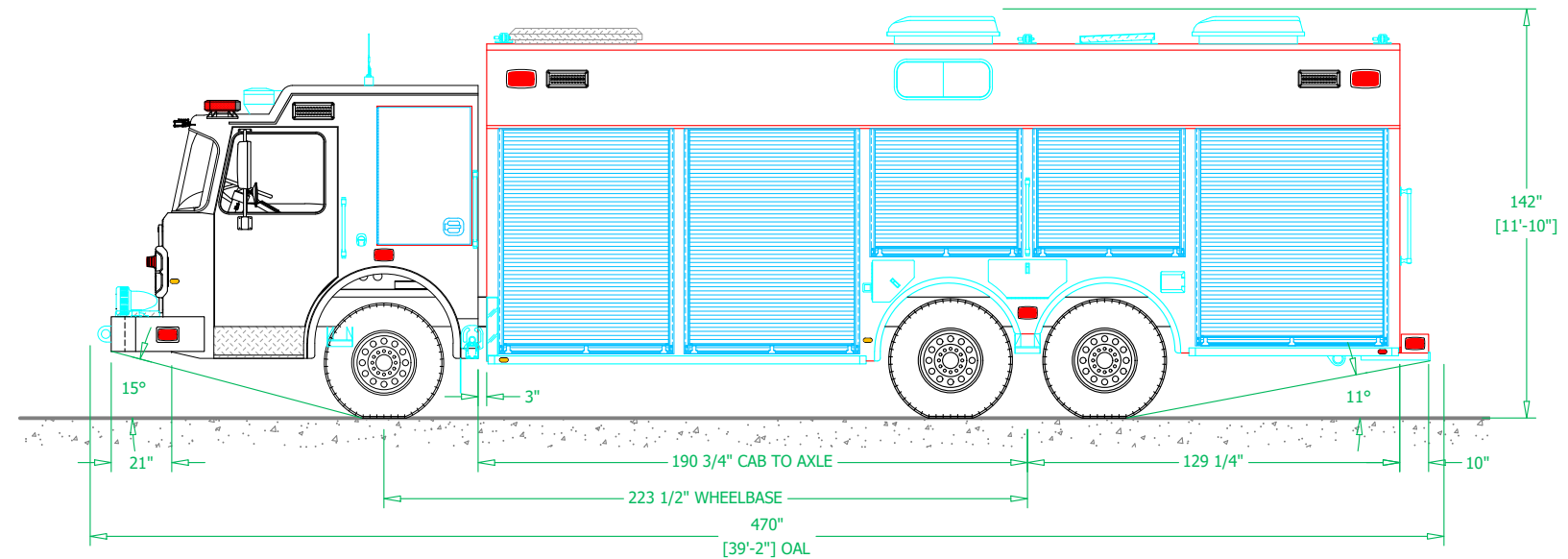
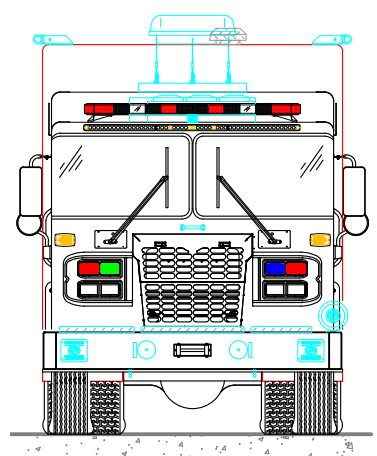
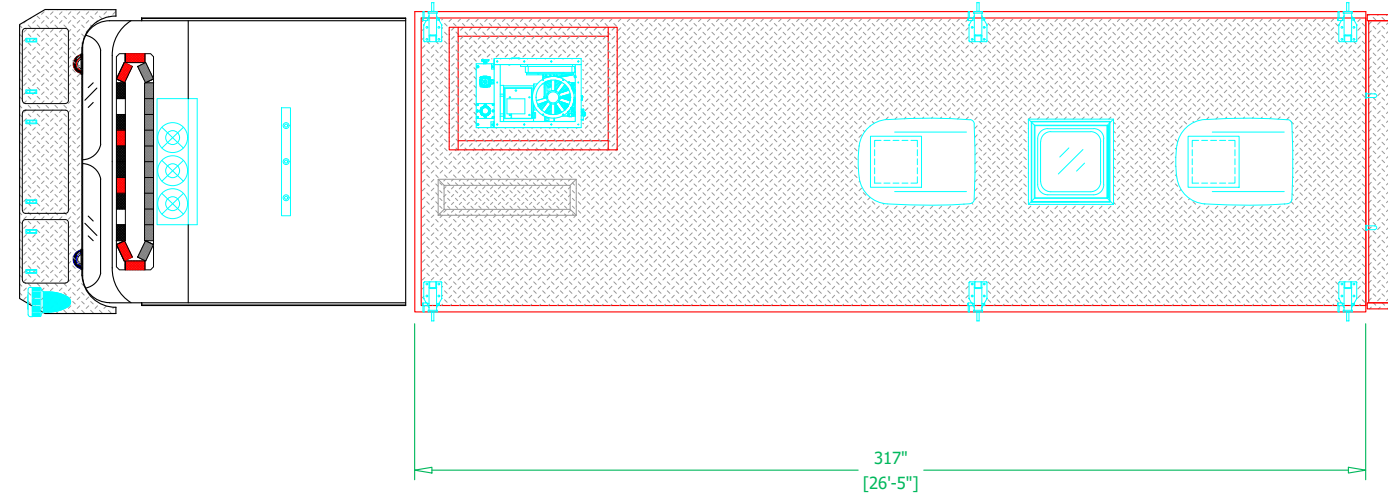

PRELIMINARY DRAWING - FOR LAYOUT PURPOSES ONLY

REVISIONS			
REV	DESCRIPTION	DATE	BY

NOTE 1: Do not scale drawing. This drawing is for general truck configuration only. All items and dimensions shown are approximate and may vary with final production. The drawing may not provide illustration for all items in the specification. In all situations where the drawing may contradict the specifications, the specifications shall prevail. This drawing and all data herein are provided as confidential materials and shall not be reproduced without written consent of the manufacturer.

NOTE 2: Chassis frame height will change due to axle characteristics, loading and tire dimensions which will effect the overall height dimension shown. Any overall height restrictions should take this into consideration and allow approximately 2-3 inches of tolerance.





**SVI**  
FORT COLLINS COLORADO

SVI FIRE & RESCUE TRUCKS  
3842 REDMAN DRIVE, FORT COLLINS, CO 80524 PHONE 970-297-7100, FAX 970-297-7099

**WACO**  
**FIRE DEPARTMENT**

BODY SIZE: 26' BODY	UNIT TYPE: HR
BODY MATERIAL: 3/16" ALUMINUM	TRUCK NO: SVI #xxxx
CHASSIS TYPE: SPARTAN	WHEELBASE: SEE DWG
LTD	CAB TO AXLE: SEE DWG
10" RR	OVERALL LENGTH (OAL): SEE DWG
TWO DOOR	OVERALL WIDTH (OAW): SEE DWG
	OVERALL HEIGHT (OAH): SEE DWG
DRAWN BY: RMH	DATE: February 7, 2024
DRAWING NO: Waco_TX_hr26T_Precon2	SCALE: 3/16" = 1'-0"

SHEET 1 OF 3

PRELIMINARY DRAWING - FOR LAYOUT PURPOSES ONLY

REVISIONS			
REV	DESCRIPTION	DATE	BY

NOTE 1: Do not scale drawing. This drawing is for general truck configuration only. All items and dimensions shown are approximate and may vary with final production. The drawing may not provide illustration for all items in the specification. In all situations where the drawing may contradict the specifications, the specifications shall prevail. This drawing and all data herein are provided as confidential materials and shall not be reproduced without written consent of the manufacturer.

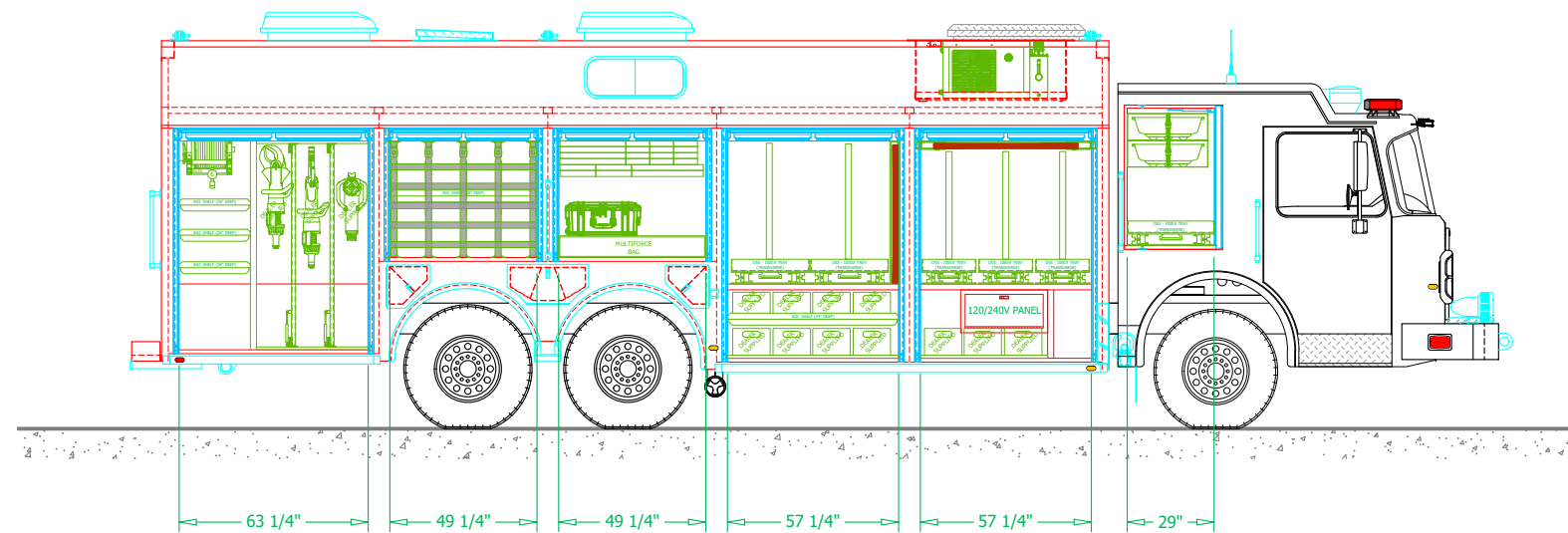
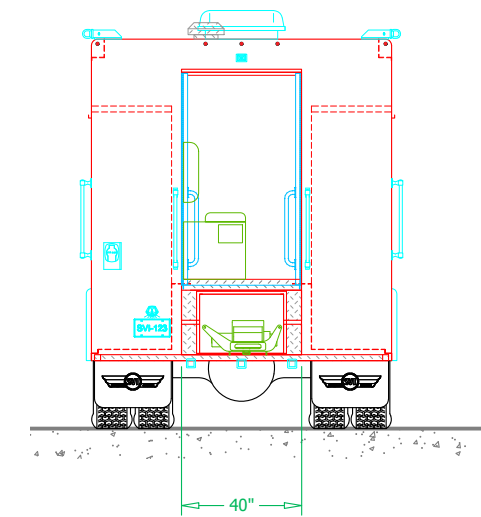
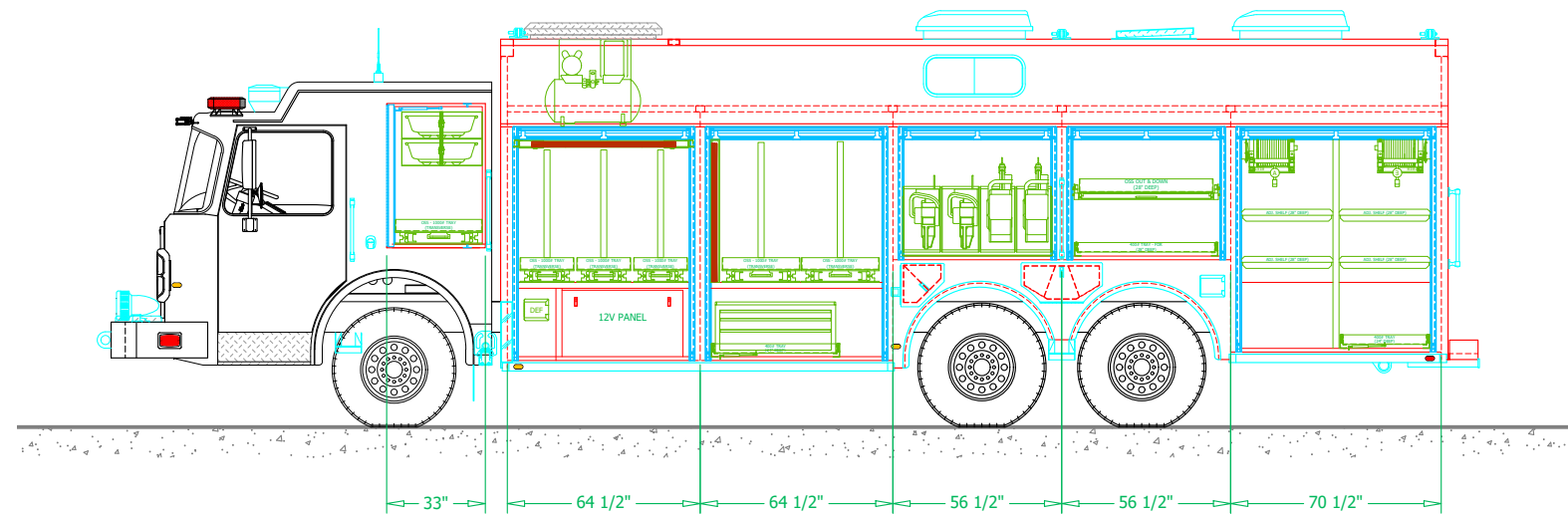
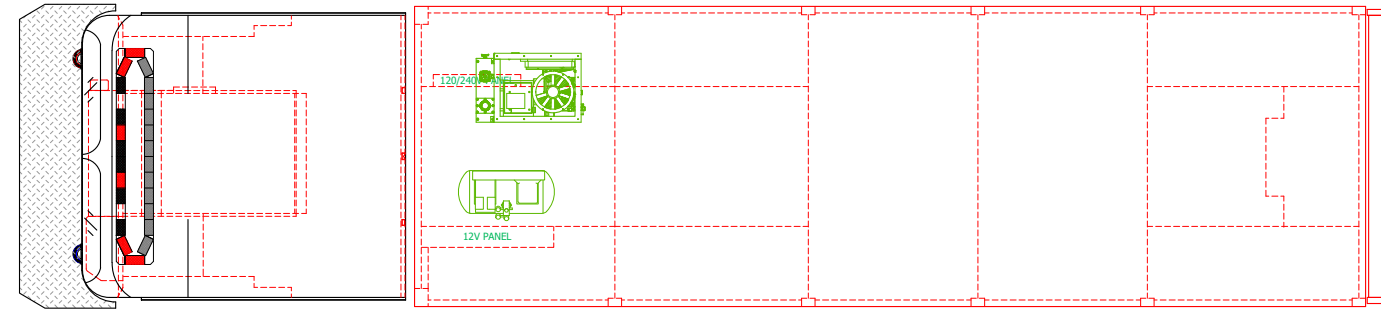

SVI  
FORT COLLINS COLORADO

SVI FIRE & RESCUE TRUCKS  
3842 REDMAN DRIVE, FORT COLLINS, CO 80524 PHONE 970-297-7100, FAX 970-297-7099

**WACO**  
**FIRE DEPARTMENT**

DRAWN BY: RMH	DATE: Feb 7, 2024	SCALE: 3/16" = 1'-0"
DRAWING NO: Waco_TX_hr26T_Precon2	SHEET 2 OF 3	

PRELIMINARY DRAWING - FOR LAYOUT PURPOSES ONLY

REVISIONS			
REV	DESCRIPTION	DATE	BY

NOTE 1: Do not scale drawing. This drawing is for general truck configuration only. All items and dimensions shown are approximate and may vary with final production. The drawing may not provide illustration for all items in the specification. In all situations where the drawing may contradict the specifications, the specifications shall prevail. This drawing and all data herein are provided as confidential materials and shall not be reproduced without written consent of the manufacturer.

PLAN VIEW

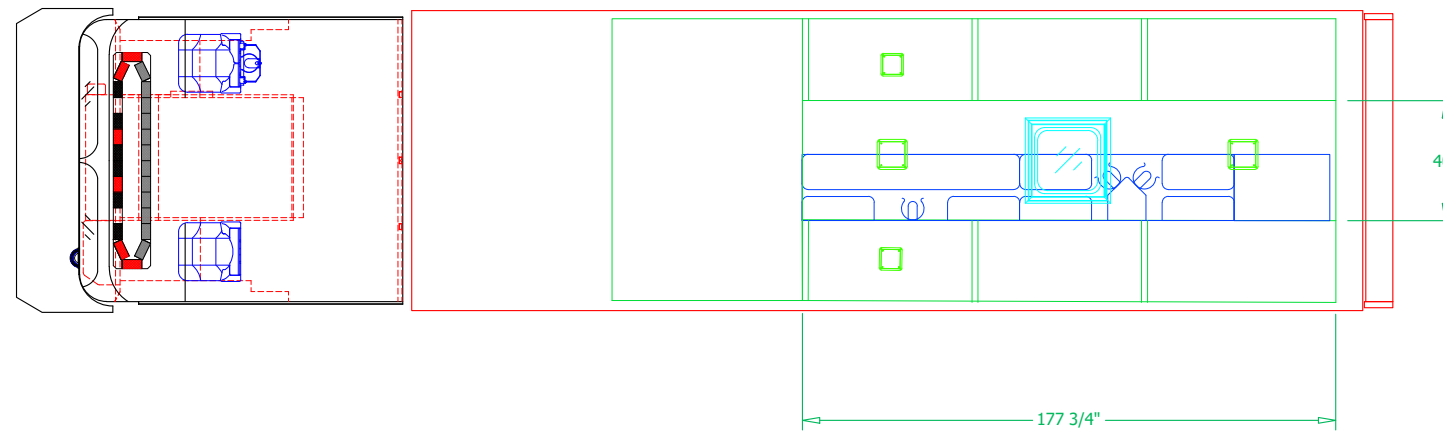

CURBSIDE INTERIOR

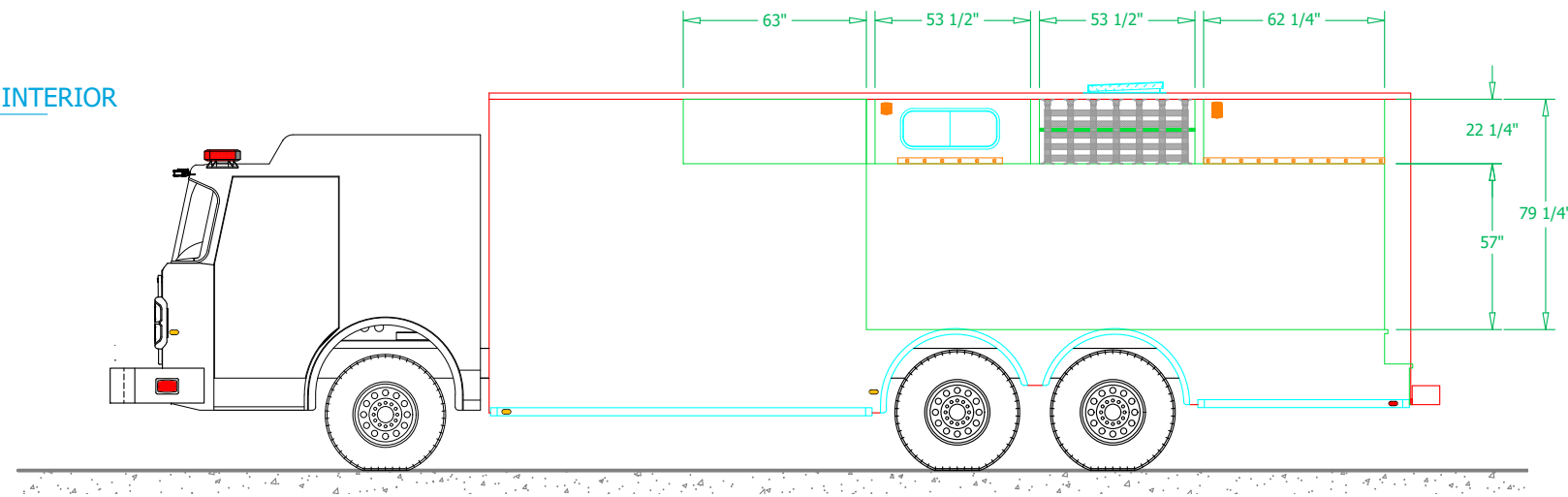

REAR VIEW  
BODY CROSS-SECTION

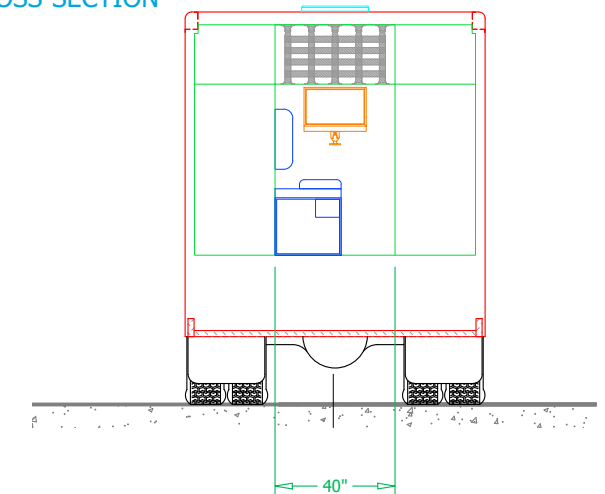

STREETSIDE INTERIOR

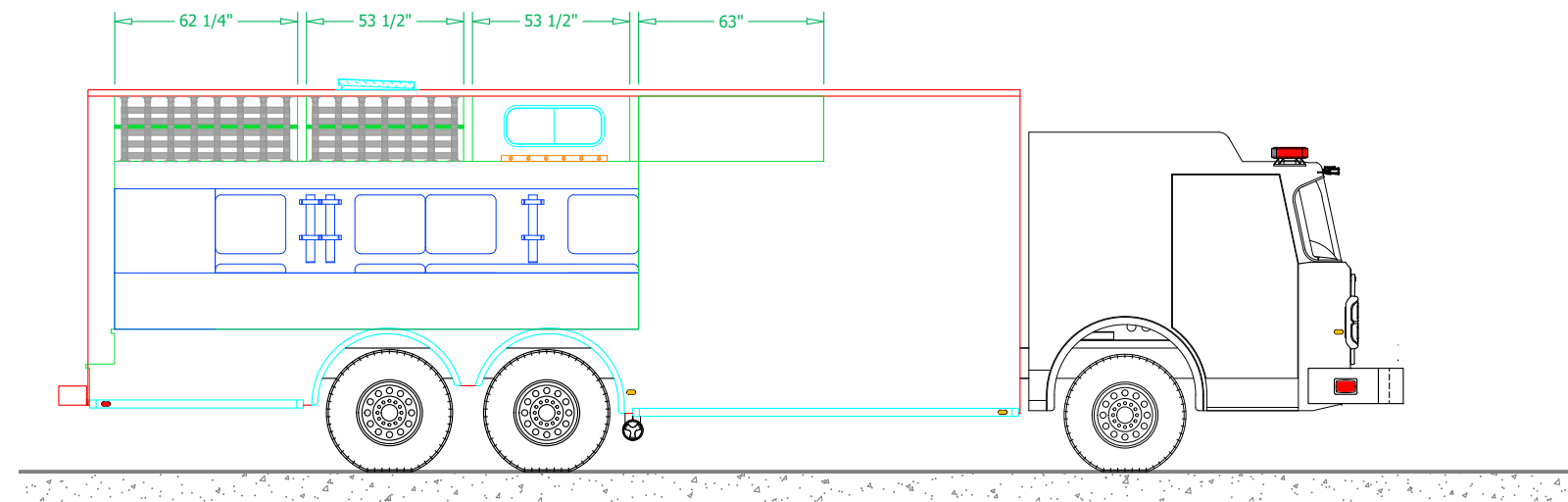

SVI FIRE & RESCUE TRUCKS  
3842 REDMAN DRIVE, FORT COLLINS, CO 80524 PHONE 970-297-7100, FAX 970-297-7099

WACO  
FIRE DEPARTMENT